

SOUTH WEBER CITY COUNCIL AGENDA

Watch live or at your convenience

<https://www.youtube.com/c/southwebercityut>

PUBLIC NOTICE is hereby given that the City Council of SOUTH WEBER CITY, Utah, will meet in a regular public meeting commencing at 6:00 p.m. on Tuesday, April 13, 2021 in the Council Chambers at 1600 E. South Weber Dr., *Due to physical distancing guidelines there is limited room for the public to attend. Unless commenting please watch on YouTube at the link above. **Attendees are encouraged to properly wear a face mask.** If you are unable or uncomfortable attending in person, you may comment live via Zoom if you register prior to 5 pm the day of the meeting at <https://forms.gle/PMJFhYFJsD3KCi899>. You may also email publiccomment@southwebercity.com for inclusion with the minutes.

OPEN (Agenda items may be moved in order or sequence to meet the needs of the Council.)

1. Pledge of Allegiance: Councilwoman Alberts
2. Prayer: Rajan Zed, President, Universal Society of Hinduism
3. *Public Comment: Please respectfully follow these guidelines.
 - a. Individuals may speak once for 3 minutes or less: Do not remark from the audience.
 - b. State your name & address and direct comments to the entire Council (Council will not respond).

ACTION ITEMS

4. Approval of Consent Agenda
 - a. March 9, 2021 Minutes
 - b. March 23, 2021 Minutes
5. Ordinance 2021-2: City Code Title 7 Chapter 4-3 Park Regulations
6. Resolution 21-20: Dog Park Rules
7. Resolution 21-21: Sewer Management Annual Report
8. Resolution 21-22: Cottonwood Drive Paving Project
9. Resolution 21-23: First Amendment to the Development Agreement for Riverside RV Park
10. Resolution 21-24: Davis County Pre-Disaster Mitigation Plan

DISCUSSION

11. Development Approach for General Plan Crosshatch
12. Poll Gateway Development Agreement

REPORTS

13. New Business
14. Council & Staff
15. Adjourn

In compliance with the Americans with Disabilities Act, individuals needing special accommodations during this meeting should notify the City Recorder, 1600 East South Weber Drive, South Weber, Utah 84405 (801-479-3177) at least two days prior to the meeting.

THE UNDERSIGNED DULY APPOINTED CITY RECORDER FOR THE MUNICIPALITY OF SOUTH WEBER CITY HEREBY CERTIFIES THAT A COPY OF THE FOREGOING NOTICE WAS MAILED, EMAILED, OR POSTED TO: 1. CITY OFFICE BUILDING 2. FAMILY ACTIVITY CENTER 3. CITY WEBSITE <http://southwebercity.com/> 4. UTAH PUBLIC NOTICE WEBSITE <https://www.utah.gov/pmn/index.html> 5. THE GOVERNING BODY MEMBERS 6. OTHERS ON THE AGENDA

DATE: 04-06-2021

CITY RECORDER: Lisa Smith

SOUTH WEBER CITY CITY COUNCIL MEETING

DATE OF MEETING: 9 March 2021 **TIME COMMENCED:** 6:00 p.m.

LOCATION: South Weber City Office at 1600 East South Weber Drive, South Weber, UT

PRESENT: **MAYOR:** Jo Sjoblom (excused)

MAYOR PRO TEM: Angie Petty

COUNCIL MEMBERS: Hayley Alberts
 Blair Halverson
 Angie Petty
 Quin Soderquist
 Wayne Winsor

CITY PLANNER: Shari Phippen

CITY RECORDER: Lisa Smith

CITY MANAGER: David Larson

Transcriber: Minutes transcribed by Michelle Clark

ATTENDEES: McKay Winkel, Paul Sturm, Ken Leetham, Corinne Johnson, Spencer Hafer, Kory Larsen, Brad Brown, Sky Hazlehurst, Alexia Alberts, and Farrell Poll.

Mayor Pro Tem Petty called the meeting to order and welcomed those in attend.

1. Pledge of Allegiance: Councilman Winsor

2. Prayer: Councilman Soderquist

3. *Public Comment: Please respectfully follow these guidelines.
a. Individuals may speak once for 3 minutes or less: Do not remark from the audience.
b. State your name & address and direct comments to the entire Council (Council will not respond).

Paul Sturm, 2527 Deer Run Drive, commented on House Bill 98 and ensuring that all timelines are met so the developer can't bring in their own representatives. He suggested passing a resolution which would require that various documents could only be submitted on specific days. He charged the developers of the South Weber Gateway Concept Design to view the You Tube video from the 17 November 2020 City Council meeting. He was extremely concerned with parking and further requested review of his public comments of 17 November 2020. He believed the developer is counting the uses within the project area two or more times. He questioned how

100 townhomes could be proposed on the 11 acres when the northern portion is being proposed as commercial and the highest residential density is R-7. He queried how the “unbuildable” area is figured into the calculation.

PRESENTATION:

4. Development Concept Presentation for Poll Property

Mayor Pro Tem Petty explained during the City Council meeting on February 23, 2021, the Poll property was discussed as it relates to the General Plan and potential development. Collier’s International, the potential developer for the property, updated their concept and was prepared to discuss the proposal with the City Council to seek direction on the development plan and development agreement identified as needed by the General Plan.

Sky Hazlehurst, of Collier International and representing the Poll family, announced they removed the apartments. The parking ratio is approximately 3 to 3.5 vehicles per unit. Most of the townhomes will have their own driveways. The garage will allow two cars and the driveway will allow an additional two which is four per unit. There may be some townhomes with a one car garage and two bedrooms. The commercial has been pushed all along the frontage as Council requested with a maximum of 15,000 sq. ft.

The Phasing Plan includes:

Phase 1: 5,000 sq ft. of commercial built congruently with the first 50 townhouses.

Phase 2: 5,000 sq. ft. of additional commercial built congruently with the second 50 townhouses.

Phase 3: The final 5,000 sq. ft. of commercial with remain unbuilt until the commercial user is found. (A BTS pad for the “anchor tenant”).

Brian Brown, of Collier International, petitioned for the City Council’s feedback. Councilman Soderquist queried if they lost any commercial tenants with the changes. Sky replied the two drive thru tenants have been willing to relocate. Councilman Halverson expressed 100 units is too many. Sky replied the development must be viable. Councilman Halverson thought 100 units would create a safety issue with an increased amount of traffic on South Weber Drive and suggested starting out with the R-7 Zone. Sky was willing to have a traffic study completed for the area. Councilman Winsor thanked Sky for presenting this information, but he was not in favor of 100 units and will vote no on anything over 35 units.

Councilwoman Alberts echoed 100 units is too high. She worried about empty store fronts in the commercial. She wanted a decrease in both the commercial and the residential units. She averred the residential density is based off the residential portion only and not the entire parcel. Mayor Pro Tem Petty discussed this parcel as unique. She estimated the commercial is just less than 50% of the buildable and questioned if the R-7 density is on the entire acreage. Sky confirmed that was correct. Councilman Halverson relayed if the density for R-7 is calculated on the entire parcel it would allow 74 units. Mayor Pro Tem Petty was open to R-7 residential calculated from 100% of the acreage if that allows the commercial to make the development viable. Sky understood at the last meeting that the density calculation was from gross acreage.

Councilwoman Alberts agreed it was mentioned but was unsure the majority held that opinion. Councilman Soderquist wanted clarification of the correct means of calculation. City Manager David Larson explained that is up to the City Council. Typically, if there is an R-7 Zone, the density calculation includes the entire acreage. Mayor Pro Tem Petty indicated their decision is just for this unique parcel. Councilwoman Alberts didn’t want to set a precedent for the other similar parcels identified on the General Plan. Councilman Soderquist indicated there should be

two ingress/egress in and out of the development. Sky identified the roads on the plan that meet that need.

Councilwoman Alberts asked the developer their opinion on the amount of commercial development. Sky related his builder (Millcreek) is okay with the commercial square footage. He advised the commercial should be neighborhood uses. Councilman Soderquist asked about limitation for utilities. City Manager David Larson commented there is 150 equivalent residential units (ERU's) for this development.

Councilman Halverson liked the phasing plan but commented on the large non-buildable area. He explained using that area to calculate the density yet being unable to use it condenses everything and makes it seem tight. He expressed the city would be conceding too much. If the developer and property owners don't agree, the parcel should remain Commercial Highway.

Sky reviewed the non-buildable area is approximately six acres and with the entire acreage calculated at R-7, 75.11 units would be allowed. He would ask the property owners if there could be some concessions. David reported the two items that need to be put together are the development plan (by the developer) and the development agreement (worked on with the developer and the committee). Councilman Halverson communicated it was clear from the last meeting that 100 units is too many. Sky was willing to rework the plan. Councilwoman Alberts questioned if the City Council can draft a development agreement without the developer and then the developer will have an idea as to what the Council is willing to accept. David replied that is an option. City Planner Shari Phippen advised against the Council drafting the development agreement and setting a specific number of units because there is a risk the developer could come back with a different design which the Council doesn't like it, but which meets the Council requirements. Councilwoman Alberts expressed the need for better efficiency and communication between the Council and the developer. Mayor Pro Tem Petty relayed aesthetically it will look better to have an apartment complex in the back of the parcel with the commercial in the front and more open space. Councilman Halverson expressed this is a numbers game versus the Council's personal opinions. Mayor Pro Tem Petty asked Sky if they can do 75% on the full acreage as R-7 which allows for 56 units. Sky replied with the current builder and contract that wouldn't work. Councilwoman Alberts explained the residential property needs to be in the R-7 zone. Discussion took place regarding the history of the creation of the R-7 zone. It was negotiated from what the citizens requested along with what will work with the city infrastructure. Councilman Soderquist suggested going with a maximum of R-7 zone on the whole property. He didn't know if you can include the non-buildable slope in the calculation. Councilman Winsor suggested R-7 zone calculated on the residential property only. He wasn't in favor of increasing the property identified for residential. Sky offered 74 to 75 units may be viable. He wasn't sure what to do if the residential is below the 75 units. Mayor Pro Tem Petty suggested entertaining the 75 residential units and the rest commercial. Councilman Halverson, Councilman Soderquist, and Mayor Pro Tem Petty were in favor of 75 units with the density being calculated from the entire parcel of property. It was decided the Committee will draft development agreement language and bring it to the City Council for review before sending it on to the developer.

ACTION ITEMS:

5. Approval of Consent Agenda

- a. February 9, 2021 Minutes
- b. February 16, 2021 Minutes

Councilman Winsor moved to approve the consent agenda as presented. Councilwoman Alberts seconded the motion. Mayor Pro Tem Petty called for the vote. Council Members Alberts, Halverson, Petty, Soderquist, and Winsor voted aye. The motion carried.

6. Resolution 21-13: Interlocal Agreement for Paramedic Services

Davis County has been working closely with all cities and fire districts within the county to facilitate a transition of paramedic service providers from the Davis County Sheriff's Office to the various cities and districts. Staff presented an overview of this transfer in concept during the January 31, 2021 Budget Retreat. This agenda item was to consider the proposed interlocal agreement that would commit the city to the transfer.

In summary, the agreement outlines the following:

- Davis County will cease providing paramedic service no later than December 31, 2022
- Each City or District will provide a commitment in writing by June 1, 2021 to provide paramedic services no later than December 31, 2022
- Davis County will cease collecting property tax revenue to pay for paramedic service no later than June 30, 2021
- Each City or District will provide funding to pay for paramedic services no later than August 30, 2021
- Davis County will continue to provide paramedic service until other entities are prepared to provide that service (i.e., licensing, staffing, equipping, etc.)
- Each City or District will pay the County for paramedic service at the rate of the current tax rate value in the City or District until each entity is prepared to provide that service
- A paramedic team is defined as a minimum of two licensed individuals - Standard response time is acknowledged as an eight-minute response on at least 90% of calls

City Manager David Larson introduced Ken Leitham, City Manager from North Salt Lake, who has been integral to this project. Ken discussed conditions being perfect to make changes as the County Commission and Sheriff are willing participants. This agreement will yield an improvement for the level of service in Davis County. There is an urgency for the transition with the county growing so rapidly. He recommended the City Council adopt the agreement. Councilman Halverson thanked Ken for his time and effort. Councilman Soderquist questioned the agreement being for 50 years. David explained that language was made in a conscious effort to fully commit all the cities.

Councilwoman Alberts questioned South Weber's timing on getting a license citing item #3 which states, *"Not later than December 31, 2022, the County will cease the provision of ALS and paramedic services. The County will not surrender the licensing authorizations it has received to provide paramedic services and which it holds as of the date of this Agreement until a new jurisdictional authority is authorized to provide the service."* Chief Tolman explained the State of Utah Bureau of EMS has a set standard of a 30-day review period before they issue licenses; therefore, it depends on when South Weber City Fire Department wants to apply for it. Depending on the Safer Grant it could be this July 2021 or next July 2022. Both the city and county licenses can operate simultaneously. He then described the Safer Grant and explained the crux for the department is the staffing of three employees and the city doesn't want to commit to

a level of service that it can't provide, and the grant would allow the city to move forward with that level of staffing. Councilwoman Alberts asked about the cost of licensing. Chief Tolman explained each year there is an inspection conducted by the state to make sure the city is meeting the state legal requirements. The city does have to pay the annual inspection fee, which is approximately \$150. Councilman Winsor wondered why the Mayor wasn't signing this agreement. David indicated city code specifically states the City Manager signs contracts. Mayor Pro Tem Petty thanked everyone involved with this project.

Councilwoman Alberts moved to approve Resolution 21-13: Interlocal Agreement for Paramedic Services to be signed by Mayor Sjoblom. Councilman Winsor seconded the motion. Mayor Pro Tem Petty called for the vote. Council Members Alberts, Halverson, Petty, Soderquist, and Winsor voted aye. The motion carried.

7. Resolution 21-14: Automatic Aid Fire Agreement

Mayor Pro Tem Petty announced the language in the previous agreement did not clarify that this is an Automatic Aid Agreement not a Mutual Aid Agreement. This new document is the Automatic Aid Agreement. It means South Weber Fire and Weber Fire District will continue to support each other on calls in Uintah, South Weber, and along I-84. This change is necessitated by the acquisition of Uintah by Weber Fire District.

Councilman Halverson moved to approve Resolution 21-14: Automatic Aid Fire Agreement. Councilman Winsor seconded the motion. Mayor Pro Tem Petty called for the vote. Council Members Alberts, Halverson, Petty, Soderquist, and Winsor voted aye. The motion carried.

8. Resolution 21-15: Youth City Council Logo

Mayor Pro Tem Petty advised the South Weber Youth City Council created a logo to represent themselves and the city. As such, the logo needs to be approved by the City Council as an official logo of the city for the foreseeable future.

Jenna Johnson, Maggie Hyder, and Alexia Alberts represented the Youth City Council (YCC). Jenna related a new Youth Council logo will be beneficial to the Council, city, and citizens. The logo will brand and market the Youth Council to the community and businesses. The unique logo helps the YCC be more professional and distinct. A committee created ideas and then it was voted on by the Youth City Council. Councilman Halverson noted it looks great. The City Council agreed.

Councilman Winsor moved to approve Resolution 21-15: Youth City Council Logo. Councilwoman Alberts seconded the motion. Mayor Pro Tem Petty called for the vote. Council Members Alberts, Halverson, Petty, Soderquist, and Winsor voted aye. The motion carried.

9. Resolution 21-16: First Amendment to the Development Agreement for Riverside RV Park in South Weber City

City Engineer Brandon Jones memo of 1 March 2021 is as follows:

BACKGROUND

The Development Agreement for the Riverside RV Park was approved on June 9, 2020. A preconstruction meeting was held on October 26, 2020. Thus far the developer’s contractor has been focused on clearing and grubbing the site. The developer recently approached city staff and asked about potentially changing a couple of items from what was originally approved. As both of these items are addressed specifically in the recorded development agreement, these changes are required to come to the City Council for approval as amendments to the Development Agreement.

SECTION 17. Landscaping

The developer was hopeful that they might be able to find a secondary water source or option but has been unsuccessful in doing so. Therefore, all water used for landscaping will be culinary water (see Section 6 of DA). With this in mind they would like to revise their landscaping plan to be more water conscious and blend in more with the natural environment along the river. We have reviewed the original (May 15, 2020) plan and the proposed (January 26, 2021) plan. The following is a summary of the main differences:

Plain Differences:

Area	May 15, 2020 Plan	January 26, 2021 Plan
Entrance/Office/Det. Basin/Basketball/Pool	Native Seed and Kentucky Bluegrass	All Kentucky Bluegrass
Between Sites and Trail (North)	Native Seed	Wood Mulch
East Restroom	Kentucky Bluegrass	Grey Chat (Decorative Gravel/Sand)

Center Sections of Sites	Rock & Landscape Planters and Native Seed	Rock & Landscape Planters and Kentucky Bluegrass
South Property Line (along I-84)	Native Seed	Wood Mulch and Cobble Rock
South Sites	Kentucky Bluegrass	Grey Chat (Decorative Gravel/Sand)

Supplemental Attachments:

- Original Landscape Plan – Berg Landscape Architects, dated May 15, 2020
- New Landscape Plan – Berg Landscape Architects, dated January 26, 2021
- Revisions Narrative letter from Mike Bird (Owners Representative)

SECTION 19. Approval of Setbacks (Fencing)

The developer contacted UDOT to make sure the cable fence was located and specified in a way to make sure the desired safety would be provided. UDOT met on site with the developer. UDOT informed the developer that for the cable fence to be effective it needs to be located by the shoulder. Otherwise, it is considered a hazard. Having no significant crash history in this area, UDOT stated that a barrier would not be required. They sent a letter to the City and the developer to address the cable fence and barrier along the I-84 N/A (property) line. The developer is proposing to install an 8’ solid concrete sound wall in place of the cable barrier fence and Rhinorock fence.

Supplemental Attachments:

- Proposed Sound Wall Drawing, F-4.2
- UDOT Letter, dated 2-16-2021
- Background email from McKay, dated 2-22-2021

STAFF ANALYSIS

1. Reducing outdoor water demand is beneficial to the city's water needs.
2. Whether the change in the landscape plan increases or decreases the aesthetics of the site is subjective and not part of the staff's analysis.
3. The cable barrier fence cannot be located in the location where it would be most effective.
4. Based on the mass of the proposed sound wall and the depth of the footings in comparison to the cable fence and Rhinorock fence, it is anticipated that the solid concrete sound wall will provide a sturdier barrier and increased safety.

McKay Winkel, developer of Riverside RV Park, approached the City Council. Councilman Winsor was not in favor of rock and asked if native grasses could be planted instead. Michael Bird, of Riverside RV Park, discussed native grasses killing native flowers and turning areas into a field of weeds. He proposed wood chips in lieu of the native grass. Grey chat would be installed under the wood chips helping in conserving water and giving the area more of a camping feel. Councilwoman Alberts inquired if they intend to replace the wood chips at least every other year. Michael stated they want more of a deteriorated forest cover. Councilwoman Alberts asked about the rock identified for the tent area. Michael replied it will be grey chat. He indicated on the site plan and areas where there will be grey chat and wood chips. He also acknowledged moving the dog park to a different location. Councilwoman Alberts recounted that grass is more beneficial to RV park users. Michael offered they don't have access to secondary water, so they had to find some alternatives. He reviewed the plan is to install grey chat around the perimeter and then having wood chips on top of the chat.

Councilman Soderquist asked about the secondary water prospects. McKay Winkel replied the takeout for secondary water is on the other side of the bridge, and they have been working with Riverdale Bench Canal Company to purchase water shares. Councilman Halverson struggled with the whole perimeter now being grey gravel and grey bark and to him that is not attractive. He conceded water is an issue, but that is something that most people would recognize when they purchase property. Councilwoman Alberts would like to see the upkeep of the bark. She opposed the grey rock. She was especially concerned with the amount of grass being changed out to rock. Councilman Halverson supported the masonry fence. Councilman Halverson reported native grass is considered weeds. Councilman Winsor charged there are drought tolerant grasses. Councilman Soderquist asked if the original plan was to water with culinary water in hopes of getting secondary water later. Michael replied the original plan was to install a secondary water line just for irrigation. Councilman Soderquist encouraged the developer to stay with the original plan for watering. He recognized a cost differential between culinary and secondary, but the goal is for the campground to look nice, and Council approved the original plan. Councilman Halverson suggested reducing the amount of grass where it shows bark. Michael indicated the area in brown was supposed to be native grass and naturally watered by mother-nature. Councilwoman Alberts voiced the concern seems to be the gravel around the RV parking spaces. Councilman Winsor was fine with the mulch but discouraged the rock. Councilman Soderquist agreed. Mayor Pro Tem Petty encouraged mulch around the perimeter and grass adjacent to all RV and tent sites. Councilwoman Alberts reviewed the previous plan had all the RV sites as 70%

grass and 30% chat towards the back end. McKay clarified the original plan along the river it was identified as native grasses. Councilman Winsor suggested tabling this agenda item.

Councilman Soderquist moved to approve Section 2, Item #19 (Approval of Setbacks) of Resolution 21-16: First Amendment to the Development Agreement for Riverside RV Park in South Weber City. However, Section 1, Item #17 (Landscaping) was not approved until the developer makes the necessary amendments to be reviewed by the City Council. Councilman Halverson seconded the motion. Mayor Pro Tem Petty called for the vote. Council Members Alberts, Halverson, Petty, Soderquist, and Winsor voted aye. The motion carried.

DISCUSSION ITEM:

10. Digital Sign Upgrade

Mayor Pro Tem Petty reported CARES money is available and has been allocated for the upgrading of the city's digital sign in front of Maverik. The Public Safety Committee was tasked with researching and evaluating options related to improve the quality and safety of the sign through relocation, raising, or retaining its current location. The Public Safety Committee recommends upgrading the sign in its current location and increasing the safety of the area by working with UDOT to reduce the South Weber Drive Speed Limit to 35mph and placing at least one flashing speed limit sign for traffic heading west on South Weber Drive.

The Committee evaluated the following ideas in its deliberation process before settling on the recommendation above:

Location Options

- Current location
- Diagonal northeast across the intersection from current location
- North side of South Weber Dr on Staker Parson property near the berm
- South side of South Weber Dr close to the storage sheds

Placing the Sign on a Pole

- All locations above were also considered for a pole sign

Improving Safety at Current Intersection

- Lower South Weber Dr speed limit to 35 or 40 mph
- Convert far-right lane on South Weber Dr approaching 2700 E intersection into a right turn only lane
- Move the north bound 2700 East stop line forward
- Convert far-right lane on 2700 E approaching South Weber Dr into a no right turn on red
- Adding flashing speed limit signs on South Weber Dr westbound
- Add reflective circular mirror on southeast corner of South Weber Dr/2700 East intersection

The committee determined that visibility of the sign is best in its current location. Other options were not permitted by UDOT or didn't fulfill the visibility purpose of the sign. A pole sign is the most expensive option for the city and removes the donated work and character of the sign provided by members of the community. Sight line concerns are alleviated with a lower speed

limit. Flashing signs would increase awareness and hopefully compliance with speed limit laws. The stop line was moved forward by UDOT previously as far as they are willing to move it. Right turn on red and right turn only options are more drastic measures that the committee felt are not needed now but could be reevaluated as traffic increases in the area due to continued development.

Councilman Halverson advised it was not feasible to move the sign to a new location as it would cost approximately \$60,000 to do so. The committee recommended petitioning UDOT to change the speed limit from 45 mph to 35 mph. Councilwoman Alberts related the development of surrounding areas will bring more traffic to this area.

City Manager David Larson reported Brandon Jones' concerns with reducing the speed because it reduces the capacity of the street. There is a balance and sometimes going too far on safety measures, makes it less safe. Councilman Winsor discussed the speed on South Weber Drive being a UDOT decision. The city doesn't have control over human nature and how fast people travel. He pointed out the sign meets city code but that doesn't remove it from being a safety issue.

It was stated the cost to move the sign is approximately \$60,000 and the screen is approximately \$35,000. Councilman Halverson was leery spending that kind of money to move the sign. He specified there are no reported accidents at that intersection. He stated we can't legislate people to obey the law. He recommended replacing the screen only.

Councilman Soderquist asked if there are options to use the CARES money. David replied the Council would need to revisit the priority list as all funds are currently allocated. Councilman Soderquist requested the city staff look at options of shifting it 5 ft. one way. Councilman Halverson replied the location is the only spot available right now. Councilwoman Alberts requested information regarding the location of the sign, as she was unable to find information when she was researching this item. Mayor Pro Tem Petty advocated upgrading the sign as the money is available now and then have the Safety Committee review it again as development continues. Councilman Winsor worried once the sign is upgraded, the safety issue will be forgotten.

The City Council agreed to replace the screen on the sign and petition UDOT to conduct a traffic study and possibly reduce the speed limit because there will be future development. It was stated if this is not an option, the City Council suggested applying funds to item #3 on the priority list (South Weber Fire Department Salaries).

REPORTS:

11. New Business:

House Bill 98: City Manager David Larson reported the city will make sure they are following requirements if this bill is approved by Governor Cox.

12. Council & Staff:

Councilman Halverson: related at the Public Safety Committee meeting the budget and city sign were reviewed.

Councilwoman Alberts: reviewed the PR Committee met to discuss purchasing more microphones.

Councilman Soderquist: appreciated the efforts of each committee as they put together their budget. He met with the Contribution Advisory Board for Jack B. Parsons Gravel Pit. Donations are used for Country Fair Days. He also attended meetings with both Parsons and Geneva concerning mitigating dust. They discussed possible studies for how far dust travels but wondered what could be done with the information once it was gathered.

Mayor Pro Tem Petty: stated a zoom meeting was held with Wasatch Front Regional Transportation on March 4, 2021. The connection from South Weber City to Layton City was addressed. The next meeting will be held on May 5, 2021. David added the city is choosing to apply for an amendment request of the Wasatch Regional Front Council. Bids are being reviewed for the Canyon Meadows Park West Project. The city has applied for grant monies for sidewalk safety. She thanked the city staff and committees for all the time and effort put towards the budget.

Councilman Winsor: He reported the Code Committee met and will be forwarding information to the Planning Commission which will then come to the City Council for review. Finance/Administration Committee discussed projection planning and creating a document for capital requests. The Municipal Committee will be meeting tomorrow to discuss the upcoming budget, street light replacement program, etc.

City Manager David Larson: He thanked all the committees as they have been working very hard. The city staff is grateful for all their efforts.

ADJOURN: Councilman Winsor moved to adjourn the Council Meeting at 8:46 p.m. Councilwoman Alberts seconded the motion. Mayor Pro Tem Petty called for the vote. Council Members Alberts, Halverson, Petty, Soderquist, and Winsor voted aye. The motion carried.

APPROVED: _____ Date 04-13-2021
Mayor: Jo Sjoblom

Transcriber: Michelle Clark

Attest: _____
City Recorder: Lisa Smith

From: [Jordan Skeen](#)
To: [Blair Halverson](#); [Hayley Alberts](#); [Public Comment](#)
Subject: Re: La Roca and Old Maple Farms Development
Date: Tuesday, March 2, 2021 4:43:30 PM

Councilman and Councilwoman thank you for your responses and following up. I appreciate all you are doing.

I am a little disappointed that the signs haven't been already received but we will take what we can get.

Thank you.

On Mon, Mar 1, 2021, 9:05 PM Jordan Skeen [REDACTED] > wrote:

Hello

Just wanted to follow up and see if there were any developments on the signs that La Roca is "supposed" to setup. Also have you heard anything on the DCSO on patrolling the area?

Thanks

On Tue, Feb 16, 2021, 12:58 PM Blair Halverson <bhalverson@southwebercity.com> wrote:

Jordan,

I completely agree with you and understand your frustration. I will make the request for more attention from the DC Sheriff. I know that the owner of the Soccer Complex had a deadline to get the signs made and installed, I will find out what the status of those are.

Take Care,
Blair Halverson

From: Jordan Skeen [REDACTED]
Sent: Tuesday, February 16, 2021 7:27 AM
To: Hayley Alberts <hAlberts@southwebercity.com>; Public Comment <publiccomment@southwebercity.com>
Subject: Re: La Roca and Old Maple Farms Development

Hello Again

When is enough, enough? I just woke up this AM to snow just like everyone else. So just like everyone else I begin to shovel my driveway and remove snow. As I am doing this I am seeing car after car either blow completely blast through the stop sign or slow down slightly before turning onto Silver Oak lane. I have over a minutes worth of video capturing this this morning. It's bad enough that this happens all the time but it's enough worse with snow. And you can guess where each car was headed?La Roca.

Where are the supposed signs regarding no La Roca traffic? Where is the police presence?

In the summer we had a Davis County Sheriff come and patrol and noticed a handful of violations. But they haven't been back. If it's a problem, then something needs to be done.

Sincerely a concerned citizen

On Wed, Oct 7, 2020, 2:24 PM Hayley Alberts <hAlberts@southwebercity.com> wrote:
Hello Jordan,

I apologize for not getting back to you sooner. I strive to respond to emails from residents quickly but got a little slammed last week and am catching up now.

Thank you so much for sending in your concerns and experiences with the soccer complex. As you may be aware of at this time, the council took quite a bit of time to work on a new and improved Conditional Use Permit for the soccer facility that will hopefully address many of the concerns that were brought up. I tried to do everything within our power as a city to require the soccer to mitigate the concerns that have been raised and I am hopeful we were able to accomplish the task. If you weren't able to catch the meeting and would like to review the meeting you can see it on the city's youtube channel. If you would like a copy of the CUP I will get it to you as soon as it is published.

Thanks again for your input and time to communicate with us. Please let me know if there is anything else I can do.

Hayley Alberts

South Weber City Council
801-814-9595



From: Jordan Skeen [REDACTED]
Sent: Tuesday, September 29, 2020 9:09 AM
To: Public Comment <publiccomment@southwebercity.com>
Subject: La Roca and Old Maple Farms Development

Hello,

My wife and I live on the corner of Old Maple Rd. We purchased our home almost a year ago to-date. We were so excited to be moving into such an amazing community and area.

When spring time came around we shortly realized that our quiet little road was not so quiet. La Roca players, coaches, parents speeding through our neighborhood and running the stop sign in front of our house. We have communicated to the city and city councilmen. Since that time a sheriff has come and witnessed several traffic violations and issues with those late to practices, games, etc.

When school is out, I rarely have my kids outside as the road is littered with speeders and stop sign violators. La Roca has become such a problem that the whole neighborhood is concerned that someone is going to get hurt.

Before this happens I hope that action could be taken to avoid someone getting seriously hurt.

**Comments to South Weber City - City Council
for 09Mar21 Meeting
by Paul A. Sturm**

General Comment- Public Comment on HB98

1) It is my understanding now that HB98 passed and is awaiting the Governor's signature. As of today the State's Legislative website shows that it is still in the Legislative Research and General Counsel / Enrolling. How did it get slipped through?

2) What can SWC do to ensure that all of the timelines thrust upon the City be met so that the "wonderful " developers can't bring in their own hand-picked representatives to do their bidding. What can we do to prevent this from happening? Can we pass a resolution that states that these various documents, with timelines, can only be presented/delivered to the City at a specific time during the week so that the City can be responsive and meet these new deadlines. Do we have a time stamp machine to accurately document when a document is delivered to the City and signed/initialed so we do not get "Hoodwinked" by a developer.

Agenda Item 4 - Comments on South Weber Gateway Concept Design

1) Suggest the Developers / Designers of the SW Gateway Project thoroughly review the YouTube video from the 17Nov20 City Council meeting. Several of the City Council's comments/concerns still have not been addressed in this sketch.

2) The next item that I would like to address is somewhat a repeat of what I presented on 17Nov20. For the original townhome area of the proposed development shown during that meeting I addressed "parking" as a concern. The issue of, "Parking" for the homeowners and their visitors was a major issue for the Lofts Townhome development that had to be addressed before any approval was considered. The same needs to be done for this development now that it is proposed as all Townhomes. Please review my Public Comments made during that 17Nov20 meeting that mentioned inadequate Townhome parking. Please note that the number agreed upon by both the City and the Lofts Developer was 2.5 parking slots per Townhome unit, on average. This should be the "Standard" for the City.

3) A major concern that I have has to do with the developer counting the uses within the project area two or more times. With an R-7 designation, that is the City's present maximum density for housing units, how can one propose a "Not-To-Exceed" of 100 Townhomes on the ~ 11 acres when the northern portion is being proposed as Commercial. That amount of land needs to be deducted from the overall acreage when computing the land area available for townhomes. The current sketch shows 74 townhomes so why state an "Not-To-Exceed" of 100? How is "Unbuildable" area considered in this calculation?

4) Hopefully the Developers will address their anticipated development phases plan during their presentation tonight since that will have a large impact on project considerations. This has not been accomplished so far as previously requested!

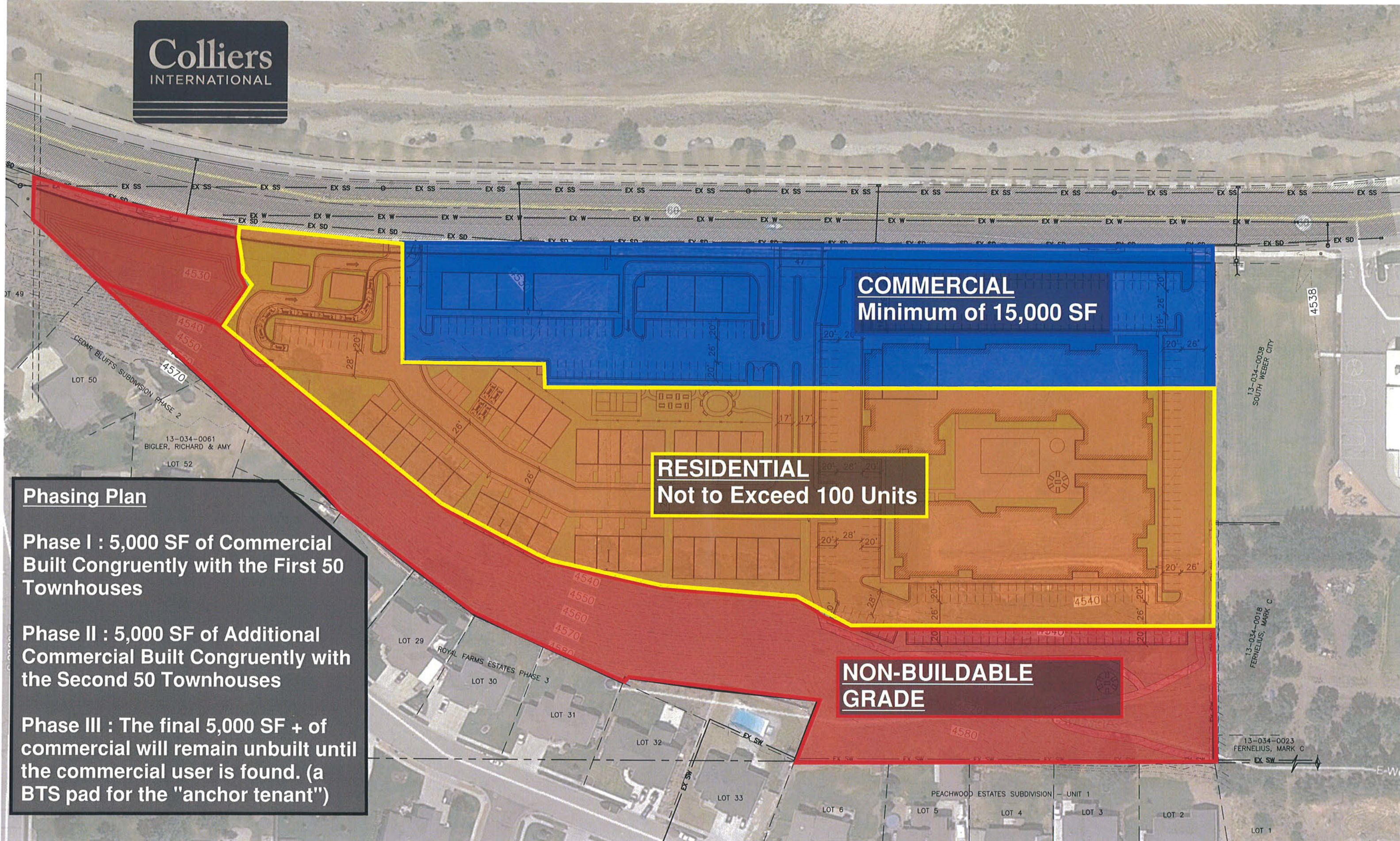

COMMERCIAL
Minimum of 15,000 SF

RESIDENTIAL
Not to Exceed 100 Units

**NON-BUILDABLE
GRADE**

Phasing Plan

Phase I : 5,000 SF of Commercial Built Congruently with the First 50 Townhouses

Phase II : 5,000 SF of Additional Commercial Built Congruently with the Second 50 Townhouses

Phase III : The final 5,000 SF + of commercial will remain unbuilt until the commercial user is found. (a BTS pad for the "anchor tenant")

SOUTH WEBER CITY CITY COUNCIL MEETING

DATE OF MEETING: 23 March 2021 **TIME COMMENCED:** 6:01 p.m.

LOCATION: South Weber City Office at 1600 East South Weber Drive, South Weber, UT

PRESENT: MAYOR: Jo Sjoblom

COUNCIL MEMBERS: Hayley Alberts
Blair Halverson
Angie Petty
Quin Soderquist
Wayne Winsor

FINANCE DIRECTOR: Mark McRae

CITY ATTORNEY: Jayme Blakesley

CITY ENGINEER: Brandon Jones

CITY PLANNER: Shari Phippen

CITY RECORDER: Lisa Smith

CITY MANAGER: David Larson

Transcriber: Minutes transcribed by Michelle Clark

ATTENDEES: Paul Sturm, Terry George, and Bill Petty.

Mayor Sjoblom called the meeting to order and welcomed those in attend.

1.Pledge of Allegiance: Councilman Halverson

2.Prayer: Mayor Sjoblom

3. Corona Update: Mayor Sjoblom reported Davis County Health Department has taken measures to ensure vaccination equity across ethnic groups. They are currently conducting mobile clinics for the homebound, jail, and rehabilitation centers. South Weber City has 752 total cases with six active cases. Vaccination will be open to ages 16 and older starting midnight tonight. More information is available on the city website.

4. Public Comment: Please respectfully follow these guidelines

- a. Individuals may speak once for 3 minutes or less: Do not remark from the audience.
- b. State your name & address and direct comments to the entire Council (Council will not respond).

Paul Sturm, 2527 Deer Run Drive, expressed concern with the Poll property and the developer counting the uses within the project area two or more times. He opined the density calculation should only include the residential portion. He questioned why the developer is calling the unbuildable area unbuildable. He disfavored the phasing plan presented by the developer Sky Hazlehurst. He recommended a penalty for not building commercial once residential is built.

Bill Petty, 7898 S. 2800 E., acknowledged it is not an easy job to sit behind the bench as he spent four years serving on the City Council and four years as Mayor of South Weber City. He also served on the legislative committee for the Utah League of Cities and Towns. He thanked the Mayor and City Council for their service. He indicated his daughter-in-law is Councilwoman Petty. Although he doesn't always agree with the City Council, he is offended by uninformed people commenting or posting on social media. He worried some people think they should be a self-appointed gate keeper to the city. He encouraged individuals to be respectful and considerate to everyone, especially those sitting behind the bench and city staff. He charged the South Weber Citizens United Group, which consists of approximately 20% of South Weber City, to get their facts straight.

Terry George, 7825 S. 2000 E., shared he has questioned where the city is going and how it is going to get there. He acknowledged he is a member of the South Weber Citizens United Group. He was appreciative of the citizen's involvement and what the City Council and Mayor are doing to serve the city. He asked the question who works for who? He indicated some of the City Council seem to be at odds with the desires of the citizens. He suggested the City Council change their perspective to match the citizens' vision or the citizens will change their position through election.

Councilwoman Petty was given the opportunity to correct some misrepresentations from the previous meeting. First, unless you are renting or living in a home that belongs to someone else, you are a property owner. Being a property owner gives you rights. A property owner of any undeveloped land has the right to request a rezone. The request may be made by the property owner themselves or by someone else on their behalf. Second, during the General Plan the City Council acknowledged a handful of parcels that would most benefit the city by being zoned commercial, but that a development agreement could be presented to the City Council for consideration so that there would be a cohesive project on that parcel. This process was approved by the Planning Commission and City Council members when the General Plan was adopted.

She reviewed a presentation was made at the last City Council meeting which was within the property owners rights and followed the process of the General Plan. She emphasized no step of the process was missed, nothing was signed, and nothing illegal transpired. It is the duty as Council members to hear out every proposal. Having a dialogue and discussion is how the City Council evaluates every situation. There are many aspects to the development process and listening to every side and considering every scenario is what she believes is the mark of a receptive Council member.

Councilwoman Petty added South Weber City is 4.6 sq. miles which essentially makes everyone neighbors. The discussion on our neighbor's property has many facets and has elicited many opinions. The City Council's job is to determine what is best for South Weber City as a whole. Just because your neighbor feels differently about a parcel, doesn't make either of you wrong. And that extends to the Council; each can have a different opinion without being wrong. She

asked all residents and Council members to remember that as this process unfolds. She quoted her wise father, "That's what makes America great!"

Councilman Soderquist apologized to the City Council and public for how he approached discussions at City Council meetings. He explained his process. When he attends meetings, he comes with an open mind, even though he may be leaning towards a certain position. He feels he can make a better informed decision if he can state and understand the pros and cons of each side. Stating a certain pro or con does not mean he is stating his position, and it is simply to provide information for the discussion. He proceeded this way during the Planning Commission and the Poll family property discussions. He referenced Mr. George's comments that Councilman Soderquist supported his point of view on the Planning Commission discussion. He clarified that he also mentioned the cons of that and other items. When the final summary came it surprised some who thought he was leaning differently.

The same thing occurred with the Poll family property discussion. When he asked for clarification as to what acreage could be included in an R-7 Zone, the response was there is not a clear definition for this case because it involved commercial and residential. Thus, the discussion became whether it should be all or just that which is identified residential or something in between. His initial comments were to include all the acreage in the R-7 discussion, but less would be appreciated. He questioned whether the non-buildable area should be calculated for density and then he mentioned his preference would be R-7 on the residential and commercial only. He was still concerned with the possible super R-7 Zone that would be created if the entire acreage were included with the commercial on top of it. He was concerned of the potential increase in traffic and safety issues with that many units on top of the commercial. He related when Councilwoman Petty summarized the discussion, she included him in agreeing to up to 75 units based on all the acreage. At that time, he did not correct her because he still wasn't sure where he wanted to be; however, he understands now he probably should have stated he was still uncertain.

He expressed his first choice for the Poll property is for the entire parcel to be useful commercial as identified in the General Plan; however, the current developer stated that would not be a financially feasible option because they don't have a large anchor business that would bring more people for other commercial business. He related South Weber City is not like Layton or Riverdale and that is why there is a need to discuss what amount of residential the City Council will consider on that parcel to get the commercial. That discussion was to provide some guidance to the developers so they could decide if they want to continue and not a firm decree. The developer is still required to go through the proper steps to meet City Code for the development.

Councilman Soderquist continued to research and study this proposal. His current stance is R-7 density on the residential and open space hillside acreage and that is what is currently written in the General Plan. He advised page 15 states "gross acreage is defined as all property within a defined area including lots, streets, parking areas, open space, and recreational uses. For the purpose of calculating new development densities, all areas within the development boundaries will be included". He clarified there were three different areas: commercial, residential, open space (unbuildable hillside). According to the General Plan definition the maximum acreage would be based off the residential and open space. It would not include the commercial; therefore, it would be fewer than 75 units. He expressed his continued concern about safety with additional traffic from 75 units plus the commercial. He summarized he is not in favor of 75

units on that parcel as currently proposed, but he does want at least the amount of commercial proposed.

Councilman Halverson reminded everyone it was a discussion item. No vote was taken. The development agreement will be reviewed again by the City Council. The committee and city staff still need to decide what will be included in the development agreement.

Mayor Sjoblom commended the City Council for their professionalism and all they do as they serve on the City Council.

ACTION ITEMS:

5. Consent Agenda

- **23 February 2021 Minutes**
- **February Check Register**
- **January Budget to Actual**

Councilman Halverson moved to approve the consent agenda. Councilwoman Alberts seconded the motion. Mayor Sjoblom called for the vote. Council Members Alberts, Halverson, Petty, Soderquist, and Winsor voted aye. The motion carried.

6. Resolution 21-16: Construction Manager/General Contractor for Canyon Meadows Park West:

City Engineer Brandon Jones memo of 15 March 2021 is as follows:

BACKGROUND

In December 2020, the City Council approved moving forward with Phase 1 of the overall master plan for the Canyon Meadows Park (West). The Parks Committee discussed several different procurement methods: traditional Design-Bid-Build, Request for Qualifications (RFQ), Request for Proposals (RFP), Design-Build, and Construction Manager / General Contractor (CM/GC). The committee also discussed approaching different portions of project with different procurement methods. Ultimately, the committee decided to pursue the CM/GC process for the entire Phase 1 project.

The CM/GC process starts by soliciting proposals from contractors. The contractors submit their qualifications and their proposed fee to assist in the design process. Once selected the contractor becomes a partner with the city through the design process. They provide valuable input towards cost-saving construction options, constructability, etc. The city and the contractor also work together in selecting subcontractors. Once design is finished, the contractor provides a Guaranteed Maximum Price (GMP) to do the project. This price is an open-book price that is provided to the city for their review. If the city is satisfied that the pricing is fair, the contractor will move forward with construction. If the city and the contractor cannot come to terms on the price, then the city has the option to bid out the work. The committee agreed that the CM/GC process would give the most flexibility and consequently provide the best opportunity to accomplish the greatest amount of work within the amount budgeted.

REQUEST FOR PROPOSALS

South Weber City publicly solicited for proposals for CM/GC Services. The deadline for submission was March 4, 2021. The City received five (5) proposals from the following companies (listed in alphabetical order):

1. Hogan & Associates Construction
2. Hughes General Contractors
3. Jardine Malaska Construction Services (JMCS)
4. Post Construction
5. Staker & Parson Companies

EVALUATION

The evaluation committee for these proposals consisted of members of the Parks Committee (Angie Petty, Quin Soderquist, Mayor Sjoblom, Wes Johnson, David Larson, Mark Larsen, Curtis Brown, and Brandon Jones).

The proposals were reviewed and scored by each committee member according to the evaluation criteria given in the RFP. The scores were then compiled, and the committee met on March 15, 2021 to review the compiled proposal scores and discuss a recommendation. A summary of the scoring is below, in order of ranking. Scoring was out of 100 total possible points.

Company	Score	Rank
Hogan & Associates Construction	91.7	1
Hughes General Contractors	91.3	2
Staker & Parson Companies	70.5	3
JMCS	67.3	4
Post Construction	59.2	5

AWARD RECOMMENDATION

After scoring and discussion were complete, the committee unanimously decided to recommend award of the contract to: **Hogan & Associates Construction, Inc.**

Councilman Halverson expressed a conflict of interest and abstained from voting. Councilman Winsor applauded the city for choosing the CM/GC process.

Councilwoman Petty moved to approve Resolution 21-16: Construction Manager/General Contractor for Canyon Meadows Park West awarding the contract to Hogan & Associates Construction, Inc. with a preconstruction design service fee of \$12,000. Councilman Winsor seconded the motion. Mayor Sjoblom called for the vote. Council Members Alberts, Soderquist, Petty, and Winsor voted aye. Councilman Halverson abstained. The motion carried.

7. Resolution 21-17: Vehicle Replacement Policy

Mayor Sjoblom proclaimed equipment and vehicles are an integral part of the day-to-day operations of the city. They are also a major operational expense. The city is currently developing a 10 Year Capital Plan. This policy covers the equipment and vehicle portion of that plan. This policy establishes a long-term funding source and addresses the several challenges all cities face with these capital expenditures. This policy is designed to create a consistent, year to year budget program with level payments that can be anticipated and planned for.

Councilman Halverson moved to approve Resolution 21-17: Vehicle Replacement Policy. Councilman Soderquist seconded the motion. Mayor Sjoblom called for the vote. Council Members Alberts, Halverson, Petty, Soderquist, and Winsor voted aye. The motion carried.

REPORTS:

8. New Business:

Mayor Sjoblom reported Officer Mike Void advised a reduction of the speed limit on 475 East to 25 mph with signs on both ends. It is very difficult to enforce a residential zone at 30 mph. He also reported the Davis County Sheriff's Department is having a difficult time enforcing parking on city streets during the winter months from 12:00 am to 12:00 pm due to construction vehicles located along the streets early in the morning. He recommended a code change 12:00 am to 7:00 or 8:00 am. She requested the Safety Committee review these items and make recommendation to the City Council.

Councilman Winsor shared the America Rescue Plan Act will be issuing a sizable stimulus with the amount for South Weber City at approximately \$800,000 divided in two tranches. He requested an agenda item for discussion be added soon.

Councilwoman Alberts was contacted by a resident who would like to use the triangular piece of property across the street from the church for gardening classes. David suggested contacting Mark Larsen.

Councilwoman Alberts attended a meeting regarding the Great Salt Lake. She discussed ways to encourage citizens to conserve water. David suggested city staff research options. City Planner Shari Phippen suggested contacting Weber State University or Weber Basin for information.

Councilwoman Alberts announced Hill Air Force Base compatible use meeting will be on March 31, 2021.

Councilwoman Petty was contacted by individuals complaining of people who use the Highway 89 South Weber exit and then flip a U-turn to get back onto Highway 89. She encouraged installation of a no U-turn sign or create two left turn lanes. David reported the signage is under UDOT's control.

Councilman Halverson reported he and Councilwoman Alberts met with Old Maple Farms residents. During the meeting it was evident there is a significant amount of speeding traffic on Old Maple Farms Rd. The Public Safety Committee will further review this issue.

Councilman Halverson met with Mayor Sjoblom and city staff concerning the Stephens' property. Mike Medini relayed Associated Foods was not in support of a 36,000 square foot grocery store. They brainstormed ideas for the property. There is a need for the commercial properties to have an anchor which can be commercial or residential. If the City Council desires a planned development, they need to figure out what anchor works. David reported it was difficult to receive this information and it changed his perspective. He noted all cities deal with how to decrease tax burdens for citizens. Waiting hasn't provided a different product because of

the limitations placed on the property. The City Council needs to determine the correct approach for the future. He reviewed the previous method and acknowledged Council needs to decide on a different course. Councilman Halverson stated the property owners have the right to quit claim deed the parcel and it will get subdivided somehow. He expressed these property owners are of the age that they want their property sold. He advocated bringing it back to the development agreement and having the Code Committee review the uses. He lamented under the current city code, an application for a truck stop could be requested tomorrow. Councilman Winsor declared the Code Committee has been working on amending the commercial highway zone.

City Manager David Larson drafted a document that explains the crosshatch properties development process which was displayed. It included a step-by-step process, components, and timelines. He conveyed the state's position is very specific on property rights for property owners. Councilwoman Alberts questioned how the Planning Commission can make a recommendation in conflict with the General Plan. David replied the Council took the approach that they are looking at one entire project, so the project must have parts that work together to make sense and that allows for various components. If the entire property can't be commercial, than the General Plan requires an agreement and a plan both to make the project work. When the decision was made for the crosshatch, it became one project that is cohesive. Ultimately, the city can proceed and consider the proposal and request that has come forward. The General Plan is the guiding document, but it is not iron clad to the point where consideration can't be given to decide what makes a project work. He acknowledged the considerable amount of work that took place with updating the General Plan and he wants to do what is right for the city. If the Council is desirous to just stick to allowed use, then a conversation needs to take place and the approach needs to be changed. Councilwoman Alberts stated the Mixed-Use Committee discussed adding a residential component. She expressed as a Council Member and member of that committee the intent was good but the process confusing. She suggested clarifying and simplifying the process. She questioned if an R-7 Zone should be based off 100% of the parcel. David explained there are parameters that have been put in place for the development process. Councilman Halverson asked if this is the process the Council wants to follow. Mayor Sjoblom added as a visual person she favored a cohesive development. City Attorney Jayme Blakesley discussed this being a legislative decision. He recommended against creating zoning arrangements through a development agreement.

9. Council & Staff:

Councilwoman Alberts: reported the Country Fair Days Committee is busy planning events for this summer.

Councilwoman Petty: announced the Youth City Council will be hosting the Easter Egg Hunt at Canyon Meadows Park on Monday, March 29, 2021 at 6:00 pm sharp.

Councilman Winsor: related the Municipal Utilities Committee is working with companies concerning a fiber network. They will present their findings to the City Council in a public meeting.

City Manager, David Larson: submitted a development proposal has been presented on the Watts property. He reviewed the roundabout situation and stated the city staff is proposing the round-a-bout be on the Peeks' property.

CLOSED SESSION: held pursuant to the provision of UCA section 52-4-205 (1) (d)

At 7:46 pm Councilman Soderquist moved to go into a closed session held pursuant to the provision of UCA section 52-4-205 (1)(d) to discuss the purchase, exchange, or lease of real property. Councilman Halverson seconded the motion. Mayor Sjoblom called for the vote. Council Members Alberts, Halverson, Petty, Soderquist, and Winsor voted aye. The motion carried.

10. Discussion of the purchase, exchange, or lease of real property

11. Return to Open Meeting and Adjourn

Councilwoman Petty moved to return to open meeting at 7:59 p.m. Councilman Winsor seconded the motion. Mayor Sjoblom called for the vote. Council Members Alberts, Halverson, Petty, and Winsor voted aye. The motion carried.

ADJOURN: Councilman Winsor moved to adjourn the Council Meeting at 8:00 p.m. Councilman Halverson seconded the motion. Mayor Sjoblom called for the vote. Council Members Alberts, Halverson, Petty, and Winsor voted aye. The motion carried.

APPROVED: _____ **Date** 04-13-2021
Mayor: Jo Sjoblom

Transcriber: Michelle Clark

Attest: _____
City Recorder: Lisa Smith

From: [tonya.mackintosh](#)
To: [Public Comment](#)
Subject: Poll Property-No 75 units
Date: Sunday, March 21, 2021 11:41:33 AM

I would like to comment on the Poll Property by saying no to 75 residential units. Follow the General Plan. We took this survey twice to have a voice. The Lofts are bad enough.

Sent from my T-Mobile 4G LTE Device

From: [Miranda McDavid](#)
To: [Angie Petty](#); [Blair Halverson](#); [Hayley Alberts](#); [Public Comment](#); [Quin Soderquist](#); [Wayne Winsor](#)
Subject: Developing the Poll Property
Date: Sunday, March 21, 2021 4:36:06 PM

Dear South Weber City Council, Planning and Development Committee, Transportation Committee, Safety Commission and Mayor:

I would like to formally request to please reconsider and DENY using that parcel of property (The Poll Property next to the High Mark School) to accommodate any type of apartment or residential living units.

With a minimum of two people per unit, there will be way too many cars coming and going in and out of that small area. This will not be safe for our children nor our walking residents. In addition, there is already way too much traffic congestion (as is) in and on South Weber and South Weber Drive. Adding more residential units will lead to an unsafe walking / biking situation for our residents and children as well as possibly cause added auto or auto pedestrian accidents — not to mention obstetrically causing a terrible entry and/or eye sore to our current, somewhat peaceful South Weber community.

Given the close proximity to the school and school children, we need to keep the commercial opportunities to a minimum in that area as well for the same reasons.

I understand people want to make money - but we first have to consider what is best and safe for our community. Please say no to the residential housing development that is being proposed for the Poll property and carefully weigh any businesses or developments being proposed as well.

Thank you for all you do and for hearing out and considering my request and concerns.

Sincerely,

Miranda McDavid
South Weber Resident

From: [Bart Boren](#)
To: [Public Comment](#)
Subject: Community first
Date: Sunday, March 21, 2021 4:46:16 PM

Dear South Weber City,

Unfortunately I am not very poetic or wordy in what I need to say. So simply, we (our household) are very passionate about community first, not commercial first. Please fight to keep South Weber as mall bedroom community, do not turn it into the next Riverdale or Layton. We like being unique and small, home town. Stick to the R7 rule in creating multiple homes. We do not want to become overcrowded and big city.

Thank you so much for your time and consideration,

Sincerely,

Bartand Emily Boren

From: [Daren Gardner](#)
To: [Public Comment](#)
Subject: General Plan
Date: Monday, March 22, 2021 7:42:53 PM

Please stick to the General Plan that the citizens approved. I approved it would be nice to have more commercial, but it's not worth the trade of more than 7 units per acre.

Thanks
Daren Gardner
801-941-0559

From: [Michael Poll](#)
To: [Public Comment](#)
Subject: FW: Potential Development - "Poll Property"
Date: Monday, March 22, 2021 11:19:13 PM

To the South Weber City Mayor and City Council:

Thank you for all the work you do on behalf of our city and its residents. I believe all of you have the best interest of the community in mind, even when you disagree with each other or with me.

As you consider what you will approve for the property commonly known as the "Poll Property" adjacent to the Highmark Charter School, following are my thoughts and opinions I hope you will consider.

- All parties involved (property owners, real estate agents, developers, city residents and city politicians) are likely honorable, but all have different interests and motives. I expect the owners want to maximize the sales price of their property, the agents want to facilitate a sale to earn a commission, the developers want to maximize their profit on an investment, the residents want all sort of different things and the politicians are hopefully trying to represent the interests of the citizens.
- Regardless of what the agents present, regardless of how nice they are, or whether they appear to be accommodating by dropping their request from 150 residential units to 75 units, their motives should not be misunderstood. They want to get approval to move forward with a project that will help them obtain and maximize their commission. That's not a bad or unethical motive, but it should not be a consideration of the city council.
- I believe a large percentage of the citizens provided very clear direction to the city officials during the Master Plan process. That direction was to minimize the development of high density housing within the city. In listening to each of you express your opinions in recent city council meetings, I haven't heard any of you state that you didn't get that message, loud and clear.
- Despite receiving that message, it appears that some of you may be considering discounting that clear direction, substituting it for your own desire to see the city obtain commercial development. That desire isn't a bad or unethical one. It just appears to be contrary to the Master Plan and the expressed desire of the majority of the citizens of South Weber.
- Even though the agents and those they represent may tell you the project doesn't "pencil" unless they get a significant number of residential units; please remember, it is not your responsibility to make the proposed project viable. If this project doesn't work for this developer, that's okay. Another opportunity will come, or maybe it won't. Either way, let the property owner and potential buyers make their decisions within the constraints of the Master Plan.
- I believe it remains your primary responsibility to represent the legal interests/desires of the citizens and not substitute your wisdom for this clear direction.
- I ask that you allow for no greater than R-7 density on the portion of the "Poll Property" that would be used for residential AND the amount of residential development allowed not exceed one-half of the total *developable* acreage. I believe this would set the maximum number of

residential units around 40-45 and that would be contingent upon the other portion being developed for commercial use. Phasing of the residential units may be appropriate if the demand for the commercial portion is not sufficient at this time.

- Please be clear in delivering this message to the property owners, agents and others. It's only fair to them to know where the city stands, since it seems clear where the majority of the city's residents stand. If the current developer wants to "walk", wish them great success in other endeavors.

Sorry about the length of this email. I have a tendency to avoid brevity in an effort to be understood. Even with that effort, sometimes I create confusion. I'd be happy to provide verbal clarification if you are not clear on where I stand.

Again, thank you for all you do in fulfilling your very difficult responsibilities.

--Mike Poll
1076 Skyhaven Cove
South Weber, UT 84405
801-540-8897

From: [Terry George](#)
To: [Public Comment](#)
Subject: Terry George 7825 S. 2000 E. South Weber for 23 March 2021
Date: Tuesday, March 23, 2021 5:24:26 PM

Terry George
7825 S. 2000 E.
South Weber Utah

In opening, I will share a quote from George Washington:
“I confess, that Democratical States must always feel before they can see: it is this that makes their Governments slow—but the people will be right at last.”

Circa 2007 the Air Force dramatically changed their force structure and way of operations. I strongly disagreed with this change and aggressively fought against its implementation. In a moment of “aggressive complaining” a fellow fighter pilot and good buddy we called MARSAs told me his Momma always said if you disagree you need to “change your perspective or change your position.” So Profound... I had two choices: 1- I could change my position and walk away from the Air Force after 21 years of service. Or, 2- I could change my perspective and embrace the changes my leaders had mandated and do my best to implement them and make them succeed! I continued to serve for an additional 11 years and we made a lot of great things happen for this country. I still don't agree with the Air Force's dramatic change. I think the Air Force could have developed a better plan. But I did my duty and I made it work. I have no regrets and feel blessed for having served 32 years.

“Change your perspective or Change your position.” Some of you seem to be at odds with the desires of your citizens on how we should develop this city. The citizens of South Weber made it clear via their input to the general plan that we do not want lots of roof tops. We made it clear that we only wanted limited commercial. We made it clear that the Poll Property be zoned as Commercial Highway with no residential. So who answers to whom here? According to Google, and I quote:

“The United States is a representative democracy. This means that our government is elected by citizens. Here, citizens vote for their government officials. These officials represent the citizens' *ideas and concerns* in government” Close quote.

Also according to google, Quote:

“A dictatorship is a state ruled by one dictator or by a small clique.” Close Quote.

Some of you get that you work for us. Some of you think since we elected you you can do your own bidding. Marsa's Momma says; “Change your perspective or change your position.” I say, change your perspective to match our vision, or we will vote to have your position changed.

Thank you for your time.
TG

**Comments to South Weber City - City Council
for 23Mar21 Meeting
by Paul A. Sturm**

General Comment- Public Comment on South Weber Gateway Concept Design

- 1) Please reconsider the statement I made during the City Council Meeting of 9Mar21.
"A major concern that I have has to do with the developer counting the uses within the project area two or more times. With an R-7 designation, that is the City's present maximum density for housing units, how can one propose a "Not-To-Exceed" of 100 Townhomes on the ~ 11 acres when the northern portion is being proposed as Commercial. That amount of land needs to be deducted from the overall acreage when computing the land area available for townhomes. The current sketch shows 74 townhomes so why state an "Not-To-Exceed" of 100? How is "Unbuildable" area considered in this calculation?"
- 2) Also please remember statements and concerns expressed by City Council members during that 9Mar21 meeting.
 - a) Councilman Winsor had the same concerns that I expressed. He stated that, with the available "buildable" land, that is the property area minus the "unbuildable" area and the commercial area, which leaves approximately six acres for the townhomes. This equates to approximately a maximum of 42 townhomes.
 - b) Councilman Halverson expressed his concerns, as he has several other times, that this is one of the few properties remaining in SWC for commercial and commercial needs to be developed first, [(sic.) and not as an afterthought].
 - c) Councilwoman Alberts discussed her conversations with the developers regarding the number of townhomes proposed for this area, and that the developer Colliers International / Skye Hazelhurst ignored these concerns as expressed in his lower left-hand Notes.
- 3) Regarding the Skye Hazelhurst's presentation, it totally ignored the City Councilperson's concerns. He proposed 50 townhomes during his "Phase 1" with only about one third of the Commercial developed. "Phase 2" was a repeat of the Phase 1" verbiage, and Phase 3" was the final third of the commercial development. First of all 100 town homes is tremendously excessive (It should only be 42). Secondly, we need to have the Commercial developed more rapidly than the proposed 1/3, 1/3, 1/3. Once the townhomes are built, there is no penalty for not building the remaining commercial.
- 4) The final concern that I have has more legal ramifications regarding the other issues addressed above, namely:
 - a) Allowing all acreage in a development to be counted towards number of housing units permitted would open "Pandora's Box" with developers.
 - b) By permitting one developer to count all acreage, and not another, such as on the Stevens Property, would, as Jayme Blakesley stated during training, create a position where SWC was being "Arbitrary and Capricious" and could open SWC to a lawsuit!

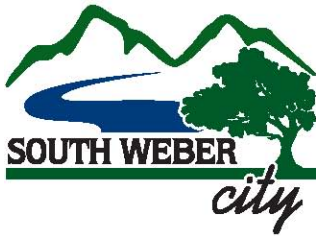

Agenda Item Introduction

Council Meeting Date: 04-13-2021

Name: Lisa Smith

Agenda Item: Ordinance 2021-02: Park Regulations

Background: The construction of the dog park prompted a look at park regulations. Staff found some necessary updates. The Parks Committee reviewed the changes and recommended the code change which will allow the park rules to be amended in the future without an additional code rewrite.

Summary: Amend Code 7-4-3: Park Regulations

Budget Amendment: n/a

Procurement Officer Review: Budgeted amount \$ Bid amount \$

Committee Recommendation: Amend Code

Planning Commission Recommendation: n/a

Staff Recommendation: n/a

Attachments: Ordinance 2021-02
Title 7 Chapter 4-3

7-4-3: PARK REGULATIONS:

The following will not be allowed in any of the City parks:

- A. Alcoholic beverages of any kind.
- B. Golfing.
- C. Dogs either with or without a leash.
- D. Any motorized vehicles of any kind, except authorized by the City.
- E. Horses.
- F. Bicycles.
- G. Overnight parking. (Res. 92-017, 8-25-1992)
- H. Smoking. (Ord. 10-01, 1-26-2010)

ORDINANCE 2021-02
AN ORDINANCE OF THE SOUTH WEBER CITY COUNCIL
ADOPTING TITLE SEVEN CHAPTER 4-3 PARK REGULATIONS

WHEREAS, the South Weber City Council desires to amend certain provisions of the Municipal Code of South Weber City relating to park regulations; and

WHEREAS, the City Council has determined that the proposed amendments will promote the public welfare and safety;

NOW, THEREFORE, BE IT ORDAINED by the City Council of South Weber City, State of Utah:

Section 1. Chapter Adopted. Chapter 7-4-3: PARK REGULATIONS of the Municipal Code of South Weber City is hereby amended to read as more particularly set forth in Exhibit A, attached hereto and incorporated herein by reference.

Section 2. General Repealer. Ordinances in conflict with this ordinance are hereby repealed to the extent of such conflict.

Section 3. Effective Date. The City Council of South Weber City, State of Utah, has determined that the public health, safety and welfare requires that this ordinance take effect immediately. Therefore, this ordinance shall become effective immediately upon passage and publication as required by law.

PASSED AND ADOPTED by the City Council of South Weber, Davis County, on the 13th day of April 2021.

MAYOR: Jo Sjoblom

ATTEST: City Recorder, Lisa Smith

Roll call vote is as follows:		
Council Member Alberts	FOR	AGAINST
Council Member Halverson	FOR	AGAINST
Council Member Petty	FOR	AGAINST
Council Member Soderquist	FOR	AGAINST
Council Member Winsor	FOR	AGAINST

EXHIBIT A
TITLE SEVEN CHAPTER 4-3 PARK
REGULATIONS

CERTIFICATE OF POSTING

I hereby certify that Ordinance 2021-02 was passed and adopted the 13th day of April 2021, and that complete copies of the ordinance were posted in the following locations within the City this 14th day of April, 2021.

1. South Weber Elementary, 1285 E. Lester Drive
2. South Weber Family Activity Center, 1181 E. Lester Drive
3. South Weber City Building, 1600 E. South Weber Drive

Lisa Smith, City Recorder

7-4-3: PARK REGULATIONS:

A. The city may purchase, lay out, establish and maintain parks and playgrounds for the benefit of the citizens of the city.

1. For purposes of this section, a “park” shall be defined as real property owned, leased or controlled by South Weber City and operated and maintained by South Weber City and set apart for the use of the general public, whether developed or undeveloped, and which is usually, or may be, planted with trees, lawns, and other landscaping, and which may include within its boundaries facilities for sport, pets, entertainment, dancing, recreation, picnicking, or swimming, or is planned for such future use.

2. The city may promulgate rules and regulations relating to the city parks and may amend such rules and regulations from time to time by resolution of the city council. Any park rules and regulations adopted by resolution of the city council shall be incorporated herein by this reference and any violation of such park rules and regulations shall be deemed a violation of this section, subject to citation, eviction, and repair as provided elsewhere in this chapter.

B. MOTOR VEHICLES:

1. **Motor Vehicles Specified:** For purposes of this section, motor vehicles include, but are not limited to, automobiles, trucks, off road vehicles, motorcycles, motorbikes, snowmobiles and any and all other self-propelled mechanical vehicles, excepting vehicles moved solely by human power, motorized wheelchairs, and electric bicycles and scooters operating at speeds lower than fifteen (15) miles per hour.

2. **Locations:** No motor vehicles may be driven at any place within a city park, other than in those areas specifically designated and posted as allowing such vehicles. This shall not apply, however, to motorized or self-propelled equipment or emergency vehicles used within the park by officers or employees of the city in the performance of their official duties.

3. **Snowmobiles and Off-Highway Vehicles:** It shall be unlawful to operate or drive any snowmobile or other off highway vehicle within any area of any city park or recreation area at any time.

4. **Speed:** It shall be unlawful to operate or drive any motor vehicle within any city park or recreation area at a speed in excess of that speed posted on the particular road, trail or pathway within the park. In the absence of a posted speed limit, no motor vehicle may be operated within any city park at a speed in excess of fifteen (15) miles per hour.

5. **Manner of Operation:** No motor vehicles, even though operated within the speed permitted on the places provided for such vehicles, shall be operated in a careless or reckless manner to such an extent that it will endanger the peace, health and safety of any other person within the city park area.

C. BYCICLES AND SKATEBOARDS: Except as otherwise posted, self-propelled vehicles such as bicycles, skateboards, roller skates, rollerblades, scooters, or motorized wheelchairs, and similar types of vehicles may be used within public parks. No self-propelled vehicles or motorized wheelchairs shall be operated in a careless or reckless manner to such an extent that it will endanger the peace, health and safety of any other person within the city park area or in any way that will damage the facilities, plants or property within the park.

D. GOLF: It shall be unlawful to play or practice golf within any city park except as part of classes or programs approved by the city.

E. SKIING: It shall be unlawful to ice skate or ski within any city park, except in specific areas as designated by the city.

F. PATHS, TRAILS OR ROADS: When a trail, path or road is designated for any specific purpose or purposes, such as an equestrian trail, bicycle path or other use, then such trail may, unless the city shall otherwise permit, only be used for the specific purposes designated or for incidental uses in connection therewith which are necessary to accomplish the use permitted.

G. ANIMALS:

1. Certain Animals Prohibited: Except as provided herein, the only animals permitted within the city parks are cats and dogs. Except as provided herein, no person shall bring or let loose any animal, other than a cat or a dog, at any time within a city park.

2. Animal Control: No person shall bring or drop off any animal in any city park for the purpose of allowing such animal to urinate or defecate upon the park property. If any animal deposits its feces on any park areas, the owners of such animal shall immediately clean up and remove such feces from the park premises. Patrons attending the city park for any reason shall keep any animal on a leash during the time such animals are within the park. Unattended or unlicensed animals found within any city park are subject to pick up by the animal control officer.

3. Tethering Animals: No person shall hitch or fasten any animal to any tree or any other place or structure on park property.

H. FIREARMS AND EXPLOSIVES: No person shall carry or discharge any firearms, firecrackers, rockets, or any other fireworks or explosives within a city park, except persons who have obtained a special permit from the city to put on a firework show.

I. FIRE MAKING: No person shall make or kindle a fire within a city park for any purpose, unless such person shall do the same in designated areas and at designated times where a fireplace or other facility intended to contain a fire is available. The city council shall designate permitted hours and seasons for permissible fireplace or fire facility use within city parks in the park rules and regulations or other resolution of the city council.

J. **CAMPING:** No person shall camp or lodge in any city park or playground. This section shall not apply to authorized city personnel for official city business or security purposes.

K. **DEFACING OR DESTRUCTION OF PROPERTY:** Except as permitted by the city, no person shall remove, injure, deface, destroy or disturb any wood, turf, grass, soil, sand, gravel, tree, shrub, plant, rock, building, sign, fence, bench or other structure, apparatus or property within a city park; or cut, take or remove any plant, or mark or write upon any building, sign, fence, bench or other structure within a city park.

L. **LITTERING:** No dumping or littering shall be allowed on any city park premises. No garbage generated outside of the park premises shall be transported to or dumped within the park or within any garbage receptacles belonging to the city and located within the park. Any garbage generated through use of the park premises shall be deposited within designated garbage receptacles.

M. **RESTROOM FACILITIES:** No male person over six (6) years of age and no female person over such age shall enter or use any restroom designated and marked for use by members of the opposite sex in a city park or playground, except that city personnel may for maintenance purposes enter any restroom.

N. **PROHIBITED CONDUCT:** No person shall engage in fighting or indulge in riotous, boisterous, intoxicated, threatening, promiscuous or indecent conduct or use any abusive, threatening, profane or indecent language in a city park. No person shall conduct any activity within a city park that poses a risk to public health and safety or which endangers the peace, health and safety of any other person within the city park area.

O. **HUNTING AND FISHING:** No person shall hunt or fish in any city park.

P. **PARK HOURS:** Unless otherwise provided by ordinance or resolution of the city council, city parks may be used between the hours of five o'clock (5:00) A.M. and eleven o'clock (11:00) P.M. City parks shall not be used or occupied between the hours of eleven o'clock (11:00) P.M. and five o'clock (5:00) A.M., except by special permission of the city.

Q. **CONCESSIONS:** No person may sell food, drinks, or other items in city parks, except as may be permitted by special permit approved by the city council.

R. **ALCOHOLIC BEVERAGES:** No person shall consume, sell, or have in their possession any alcoholic beverage within a city park.

S. **VIOLATIONS:** Any person who violates any provisions of this chapter shall be guilty of a class B misdemeanor, subject to fines, forfeitures, penalties and/or imprisonment as provided by law.

T. **EVICITION:** In addition to other remedies provided by law, any person violating any of the instructions, signs or rules established by the city may be forthwith evicted from the park by any police officer of the city.

U. PARK RESERVATIONS: Certain facilities and areas within the city parks as designated by the city may be reserved by any person upon payment of an applicable park reservation fee established by the city. Park reservation policies may be adopted and amended from time to time by resolution of the city council. The city may condition the use of city parks by organized groups, clubs, or teams on insurance, waiver, and release of liability as established in the reservation policies or rules and regulations. No individual, group, or team may occupy more than twenty-five percent (25%) of the grass area in a city park without renting the space from the city.

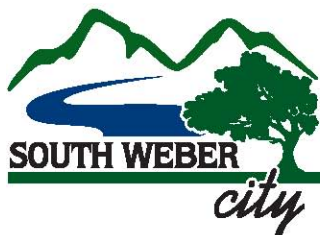

Agenda Item Introduction

Council Meeting Date: 04-13-2021

Name: Lisa Smith

Agenda Item: Dog Park Rules

Background: With the change to Title 7 Chapter 4, park rules can be updated through resolution. The Parks Committee has reviewed the rules and is recommending specific regulations for the dog park.

Summary: Dog Park Rules

Budget Amendment: n/a

Procurement Officer Review: Budgeted amount \$ Bid amount \$

Committee Recommendation: Amend Code

Planning Commission Recommendation: n/a

Staff Recommendation: n/a

Attachments: Resolution 21-18
Dog Park Rules

RESOLUTION 21-20
A RESOLUTION OF THE SOUTH WEBER CITY COUNCIL ADOPTING THE
SOUTH WEBER CITY DOG PARK RULES & REGULATIONS

WHEREAS, Section 7-4-3 of the Municipal Code of South Weber City permits the City to establish rules and regulations for City parks; and

WHEREAS, South Weber City Council desires to adopt Rules and Regulations for the dog parks within the City; and

WHEREAS, the City Council has determined that the proposed Rules and Regulations will promote the public welfare and safety;

NOW, THEREFORE, BE IT RESOLVED by the City Council of South Weber City, State of Utah:

Section 1. Adoption: The South Weber City Dog Park Rules & Regulations, attached hereto as Exhibit A and incorporated herein by reference, is hereby adopted by the City Council.

Section 2. Severability. If any section, part or provision of this Resolution is held invalid or unenforceable, such invalidity or unenforceability shall not affect any other portion of this Resolution, and all sections, parts and provisions of this Resolution shall be severable.

Section 3. Effective Date. This Resolution shall become effective immediately upon its approval by the City Council.

PASSED AND ADOPTED by the City Council of South Weber, Davis County, on the 13th day of April 2021.

Roll call vote is as follows:		
Council Member Winsor	FOR	AGAINST
Council Member Petty	FOR	AGAINST
Council Member Soderquist	FOR	AGAINST
Council Member Alberts	FOR	AGAINST
Council Member Halverson	FOR	AGAINST

MAYOR: Jo Sjoblom

ATTEST: City Recorder, Lisa Smith

EXHIBIT A

DOG PARK RULES AND REGULATIONS

:

**SOUTH WEBER CITY
DOG PARK
RULES & REGULATIONS**

Hours of Operation: 6:00 AM until sunset daily

- 1) No animals other than dogs may be brought into the fenced area.
- 2) All dogs shall wear a collar with identification, license, and vaccination tags at all times while in the park.
- 3) All dogs must be leashed until safely inside and returned to a leash prior to exiting the fenced area. Owners must have one leash per dog at all times.
- 4) Dog owners must remain in the fenced area while their dogs are using the dog park. Owners must be in view of their dogs with voice control at all times.
- 5) Dog owners must be age 18 or older to be allowed in dog park area unsupervised. Children accompanying dog owners must be strictly supervised by an adult and be at least 12 years old to be allowed inside. Spectators should remain outside the fenced area.
- 6) Aggressive dogs and female dogs in any stage of heat are prohibited. Owners must immediately leash and remove dogs from the dog park at the first sign of aggressive, hostile, combative, or reproductive behavior. Any dog found to have bitten another dog or person will be permanently excluded from the dog park.
- 7) Dog owners shall clean up after their pet. If any dog deposits its feces on any park areas, the owner of such dog shall immediately clean up and deposit such feces in the trash.
- 8) Small, bite-sized training treats are permitted. Food in bowls, long-lasting chews, or glass containers is prohibited.
- 9) Dog park patrons are prohibited from smoking or eating inside the "dog park." Cigarette butts and food wrappers are tempting and unhealthy for dogs. Wrappers and other litter can be eaten by dogs and cause a choking or digestion hazard which can be life threatening.
- 10) Sick or injured dogs are prohibited from the dog park. Owners of dogs with a known sickness/injury or displaying sick or injured behavior will be required to remove their dog immediately.
- 11) Each adult may have a maximum of two (2) dogs at a time in the park.
- 12) Puppies less than four (4) months old or dogs that have not been vaccinated are not permitted.
- 13) All dog bites must be reported to the Animal Control Office at 801-444-2206. In addition, owners are required to assist in the investigation of incidents of aggression or biting by providing appropriate identification and information to the Police, Parks & Animal Control Office, and to other dog owners who are involved with the incident under investigation. Failure to provide assistance and identification as requested will result in immediate revocation of all dog park privileges. Owners are liable for any injury or damage caused by their dog and are fully responsible for their dog's actions.
- 14) Owners are solely responsible for any injury or damage caused by their dog. Dog owners must supervise their dog at all times. No dog may be left unattended.
- 15) If a dog inflicts an injury, the dog's owner must give their name and telephone number to the owner of the injured dog before leaving the dog park.
- 16) Digging should be prevented as much as possible. If a dog digs, the dog's owner must fill all holes dug by their dog(s) as soon as possible. **45 of 103**

- 17) All dogs and owners use the dog park at their own risk. Neither South Weber City nor South Weber City Parks and Recreation Department shall be liable for any damage caused to property, a person, or a pet.
- 18) Patrons use the dog park at their own risk. By using the park, patrons accept responsibility for their actions and those of their dog(s).
- 19) With the exception of wheelchairs or similar mobility devices, vehicles are not permitted in the dog park. Vehicles include but are not limited to strollers, bicycles, tricycles, big-wheels, wagons, and rollerblades.
- 20) Patrons of the dog park must wear shoes at all times.
- 21) No attendant will be on duty.
- 22) Owners who fail to abide by rules and regulations are subject to loss of dog park privileges.
- 23) Choke, spike, pinch, prong, or collars that may injure other dogs are prohibited. Such collars must be removed BEFORE entering the fenced area.
- 24) The off-leash dog area is for dogs, their handlers and those accompanying them. No other use is allowed. These areas are designated for canine activities. It is not intended for any other purpose.
- 25) Violation of these rules is cause for loss of dog park privileges and may result in trespass, criminal, or civil penalties as provided in City Code.

Basic Etiquette, Guidelines and Tips for Use of the Dog Park

- 1) Keep walking or playing – this helps keep the off-leash area "neutral" territory for all.
- 2) Keep your dog on leash until you enter the off-leash areas. Carry a leash on you for each dog at all times while in the park.
- 3) Dogs shall be under your visual contact and voice control at all times; stay within close range of your dog.
- 4) Be aware that dogs have different play styles. Talk to your veterinarian. Talk to other park users. Educate yourself on dog behavior.
- 5) Ensure each gate closes behind you before you enter or exit the next one.
- 6) Fill in any holes your dog digs and make appropriate repairs to disturbed areas.
- 7) Do not bring a dog with a known history of biting or fighting.
- 8) Leave the park cleaner and in better condition than you found it.

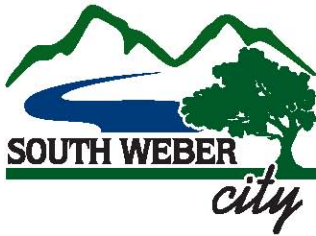

Agenda Item Introduction

Council Meeting Date: April 13, 2021

Name: Mark Johnson

Agenda Item: Sewer Management Annual Report

Background: Sewer/Storm Water Manager

Summary: Presenting the Municipal Wastewater Annual Report for the year ending 2020 for South Weber City

Budget Amendment: n/a

Procurement Officer Review: Budgeted amount \$ Bid amount \$

Committee Recommendation: n/a

Planning Commission Recommendation: n/a

Staff Recommendation: n/a

Attachments: Report

RESOLUTION 21-21

A RESOLUTION OF THE SOUTH WEBER CITY COUNCIL ADOPTING THE MUNICIPAL WASTEWATER PLANNING PROGRAM 2020 REPORT

WHEREAS, the Utah Department of Environmental Quality has created a Municipal Wastewater Planning Program (MWPP); and

WHEREAS, MWPP issues a mandatory annual survey to assist municipalities in evaluating and summarizing the technical, operational, and financial conditions of these facilities; and

WHEREAS, Sewer Manager Mark Johnson completed and filed the report; and

WHEREAS, the report requires adoption by the Council;

NOW THEREFORE BE IT RESOLVED by the Council of South Weber City, Davis County, State of Utah, as follows:

Section 1. Adoption: The Municipal Wastewater Planning Program 2020 Annual Report attached as Exhibit 1 is hereby adopted.

Section 2: Repealer Clause: All ordinances or resolutions or parts thereof, which are in conflict herewith, are hereby repealed.

PASSED AND ADOPTED by the City Council of South Weber, Davis County, on the 13th day of April 2021.

Roll call vote is as follows:		
Council Member Winsor	FOR	AGAINST
Council Member Petty	FOR	AGAINST
Council Member Soderquist	FOR	AGAINST
Council Member Alberts	FOR	AGAINST
Council Member Halverson	FOR	AGAINST

Jo Sjoblom, Mayor

Attest: Lisa Smith, Recorder

EXHIBIT 1

**MUNICIPAL WASTEWATER PLANNING
PROGRAM 2020 ANNUAL REPORT**

*Municipal Wastewater Planning Program (MWPP)
Annual Report
for the year ending 2020
SOUTH WEBER CITY*

Thank you for filling out the requested information. Please let DWQ know when it is approved by the Council.

Please download a copy of your form by clicking "Download PDF" below.

Below is a summary of your responses

[Download PDF](#)

SUBMIT BY APRIL 15, 2021

Are you the person responsible for completing this report for your organization?

Yes

No

This is the current information recorded for your facility:

Facility Name:	SOUTH WEBER CITY
Contact - First Name:	Mark
Contact - Last Name:	Johnson
Contact - Title	Sewer Manager
Contact - Email	mark.johnson@swc.org

Contact - Phone:	435-770-6098
Contact - Email:	mjohnson@southwebercity.com

Is this information above complete and correct?

Yes

No

Your wastewater system is described as Collection & Financial:

Classification: COLLECTION

Grade: II

(if applicable)

Classification: -

Grade: -

Is this correct?

WARNING: If you select 'no', you will no longer have access to this form upon clicking Save & Continue. DWQ will update the information and contact you again.

Yes

No

Click on a link below to view examples of sections in the survey:
(Your wastewater system is described as Collection & Financial)

[MWPP Collection System.pdf](#)

[MWPP Discharging Lagoon.pdf](#)

[MWPP Financial Evaluation.pdf](#)

[MWPP Mechanical Plant.pdf](#)

[MWPP Non-Discharging Lagoon.pdf](#)

Will multiple people be required to fill out this form?

Yes

No

Financial Evaluation Section

Form completed by:

Mark Johnson

Part I: GENERAL QUESTIONS

Yes

No

Are sewer revenues maintained in a dedicated purpose enterprise/district account?

Yes

No

Are you collecting 95% or more of your anticipated sewer revenue?

Are Debt Service Reserve Fund⁶ requirements being met?

What was the annual average User Charge¹⁶ for 2020?

14.33

Do you have a water and/or sewer customer assistance program* (CAP)?

Yes

No

Part II: OPERATING REVENUES AND RESERVES

Yes

No

Are property taxes or other assessments applied to the sewer systems¹⁵?

Yes

No

Are sewer revenues¹⁴ sufficient to cover operations & maintenance costs⁹, and repair & replacement costs¹² (OM&R) at this time?

Are projected sewer revenues sufficient to cover OM&R costs for the *next five years*?

Does the sewer system have sufficient staff to provide proper OM&R?

Has a repair and replacement sinking fund¹³ been established for the sewer system?

Is the repair & replacement sinking fund sufficient to meet anticipated needs?

Part III: CAPITAL IMPROVEMENTS REVENUES AND RESERVES

Yes

No

Are sewer revenues sufficient to cover all costs of current capital improvements³ projects?

Has a Capital Improvements Reserve Fund⁴ been established to provide for anticipated capital improvement projects?

Are projected Capital Improvements Reserve Funds sufficient for the *next five years*?

Yes

No
 #7 Sewer Report

Are projected Capital Improvements Reserve Funds sufficient for the *next ten years*?

Are projected Capital Improvements Reserve Funds sufficient for the *next twenty years*?

Part IV: FISCAL SUSTAINABILITY REVIEW

Yes

No

Have you completed a Rate Study¹¹ within the last five years?

Do you charge Impact fees⁸?

2020 Impact Fee (if not a flat fee, use average of all collected fees) =

Residential (Ratio - 1) \$ 2,933 Single Family, Duplexes, Townhomes, Condos
Apartments (Ratio - 0.75) \$ 2,200 per unit, 3+ units per complex Commercial 1½ " (Ratio - 1.5) \$ 4,400 Based on water meter size Commercial 2" (Ratio - 2) \$ 5,867 Based on water meter size Commercial 3" (Ratio - 6.4) \$18,776 Based on water meter size Commercial 4" (Ratio - 10) \$29,338 Based on water meter size

Yes

No

Have you completed an Impact Fee Study in accordance with UCA 11-36a-3 within the last five years?

Do you maintain a Plan of Operations¹⁰?

Have you updated your Capital Facility Plan² within the last five years?

Yes

No

Do you use an Asset Management¹ system for your sewer systems?

Yes

No

Do you know the total replacement cost of your sewer system capital assets?

Yes

No

Do you fund sewer system capital improvements annually with sewer revenues at 2% or more of the total replacement cost?

What is the sewer/treatment system annual asset renewal* cost as a percentage of its total replacement cost?

What is the sewer/treatment system annual asset renewal* cost as a percentage of its total replacement cost?

Part V: PROJECTED CAPITAL INVESTMENT COSTS

Cost of projected capital improvements

55 of 103

Cost

Purpose of Improvements

	Please enter a valid numerical value	Replace/Restore	Purpose of Improvements New Technology	Increase Capacity
2021	1300000	<input type="checkbox"/>	<input type="checkbox"/>	<input checked="" type="checkbox"/>
2021 thru 2025	800000	<input type="checkbox"/>	<input type="checkbox"/>	<input checked="" type="checkbox"/>
2026 thru 2030	1250000	<input type="checkbox"/>	<input type="checkbox"/>	<input checked="" type="checkbox"/>
2031 thru 2035		<input type="checkbox"/>	<input type="checkbox"/>	<input type="checkbox"/>
2036 thru 2040		<input type="checkbox"/>	<input type="checkbox"/>	<input type="checkbox"/>

This is the end of the Financial questions

To the best of my knowledge, the Financial section is completed and accurate.

Yes

Collections System Section

Form completed by:

May Receive Continuing Education /units (CEUs)

Mark Johnson

Part I: SYSTEM DESCRIPTION

What is the largest diameter pipe in the collection system (diameter in inches)?

21"

What is the average depth of the collection system (in feet)?

#7 Sewer Report

10 Feet

What is the total length of sewer pipe in the system (length in miles)?

37

How many lift/pump stations are in the collection system?

1

What is the largest capacity lift/pump station in the collection system (design capacity in gallons per minute)?

20 gpm

Do seasonal daily peak flows exceed the average peak daily flow by 100 percent or more?

Yes

No

What year was your collection system first constructed (approximately)?

1993

In what year was the largest diameter sewer pipe in the collection system constructed, replaced or renewed? (If more than one, cite the oldest)

2017

How many days last year was there a sewage bypass, overflow or basement flooding in the system due to rain or snowmelt?

How many days last year was there a sewage bypass, overflow or basement flooding due to equipment failure (except plugged laterals)?

The Utah Sewer Management Program defines two classes of sanitary sewer overflows (SSOs):

Class 1- a Significant SSO means a SSO or backup that is not caused by a private lateral obstruction or problem that:

- (a) affects more than five private structures;*
- (b) affects one or more public, commercial or industrial structure(s);*
- (c) may result in a public health risk to the general public;*
- (d) has a spill volume that exceeds 5,000 gallons, excluding those in single private structures; or*
- (e) discharges to Waters of the state.*

Class 2 - a Non-Significant SSO means a SSO or backup that is not caused by a private lateral obstruction or problem that does not meet the Class 1 SSO criteria.

Below include the number of SSOs that occurred in year: 2020

Number

Number of Class 1 SSOs in Calendar year

Number of Class 2 SSOs in Calendar year

Please indicate what caused the SSO(s) in the previous question.

N/A

Please specify whether the SSOs were caused by contract or tributary community, etc.

N/A

Part III: NEW DEVELOPMENT

Did an industry or other development enter the community or expand production in the past two years, such that flow or wastewater loadings to the sewerage system increased by 10% or more?

- Yes
- No

Are new developments (industrial, commercial, or residential) anticipated in the next 2 - 3 years that will increase flow or BOD5 loadings to the sewerage system by 25% or more?

- Yes
- No

Number of new commercial/industrial connections in the last year

0

Number of new residential sewer connections added in the last year

2500

Part IV: OPERATOR CERTIFICATION

How many collection system operators do you employ?

2

Approximate population served

8160

State of Utah Administrative Rules requires all public system operators considered to be in Direct Responsible Charge (DRC) to be appropriately certified at least at the Facility's Grade.

List the designated Chief Operator/DRC for the Collection System below:

	Name First and Last Name	Grade	Email Please enter full email address
Chief Operator/DRC	Mark Larsen	II	mlarsen@southwebercity.com

List all other Collection System operators with DRC responsibilities in the field, by certification grade, separate names by commas:

Name separate by comma

Collection Grade I:	Name #7 Sewer Report
Collection Grade II:	separate by comma Mark Johnson
Collection Grade III:	
Collection Grade IV:	

List all other Collection System operators by certification grade, separate names by commas:

	Name separate by comma
SLS ¹⁷ Grade I:	
Collection Grade I:	
Collection Grade II:	
Collection Grade III:	
Collection Grade IV:	
No Current Collection Certification:	

Is/are your collection DRC operator(s) currently certified at the appropriate grade for this facility?

- Yes
- No

Part V: FACILITY MAINTENANCE

Yes

No

Have you implemented a preventative maintenance program for your collection system?

Have you updated the collection system operations and maintenance manual within 103

the past 5 years?

Yes

No

#7 Sewer Report

Do you have a written emergency response plan for sewer systems?

Do you have a written safety plan for sewer systems?

Is the entire collections system TV inspected at least every 5 years?

Is at least 85% of the collections system mapped in GIS?

Part VI: SSMP EVALUATION

Yes

No

Has your system completed a Sewer System Management Plan (SSMP)?

Has the SSMP been adopted by the permittee's governing body at a public meeting?

Has the completed SSMP been public noticed?

During the annual assessment of the SSMP, were any adjustments needed based on the performance of the plan?

Date of Public Notice

09/18/2015

During 2020, was any part of the SSMP audited as part of the five year audit?

Yes

No

Have you completed a System Evaluation and Capacity Assurance Plan (SECAP) as defined by the Utah Sewer Management Program?

Yes

No

Part VII: NARRATIVE EVALUATION

This section should be completed with the system operators.

Describe the physical condition of the sewerage system: (lift stations, etc. included)

In good overall condition. No major issues.

What sewerage system capital improvements³ does the utility need to implement in the next 10 years?

Replacement projects for capacity issues (Upsizing projects)

What sewerage system problems, other than plugging, have you had over the last year?

None

Is your utility currently preparing or updating its capital facilities plan²?

Yes

No

Does the municipality/district pay for the continuing education expenses of operators?

100% Covered

#7 Sewer Report

Partially cover

Does not pay

Is there a written policy regarding continuing education and training for wastewater operators?

Yes

No

Any additional comments?

No

This is the end of the Collections System questions

To the best of my knowledge, the Collections System section is completed and accurate.

Yes

I have reviewed this report and to the best of my knowledge the information provided in this report is correct.

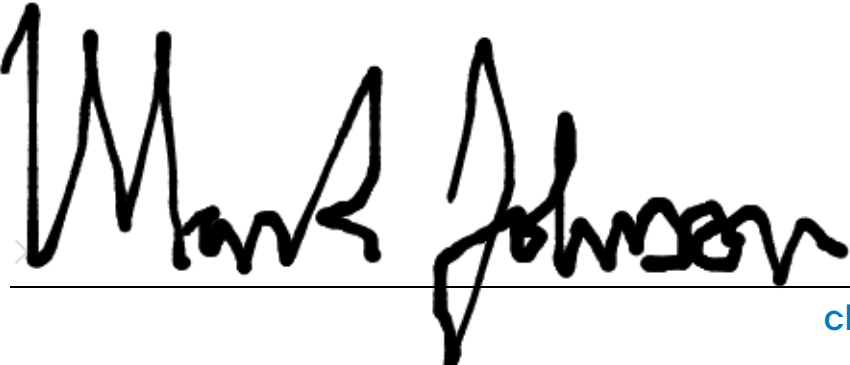
clear

Has this been adopted by the council? If no, what date will it be presented to the council?

#7 Sewer Report

Yes

No

What date will it be presented to the council?

Date format ex. mm/dd/yyyy

04/13/2021

Please log in.

Email

mjohnson@southwebercity.com

PIN

....

NOTE: This questionnaire has been compiled for your benefit to assist you in evaluating the technical and financial needs of your wastewater systems. If you received financial assistance from the Water Quality Board, annual submittal of this report is a condition of that assistance. Please answer questions as accurately as possible to give you the best evaluation of your facility. If you need assistance, please send an email to wqinfodata@utah.gov and we will contact you as soon as possible. You may also visit our [Frequently Asked Questions](#) page.

Powered by Qualtrics 



CONSULTING ENGINEERS

MEMORANDUM

TO: South Weber City Mayor and City Council

FROM: Brandon K. Jones, P.E.
South Weber City Engineer 

CC: David Larson – South Weber City Manager
Mark Larsen – South Weber City Public Works Director

RE: **COTTONWOOD DRIVE PAVING PROJECT**

Date: March 25, 2021

Today, March 25, 2021 at 2:00 pm., bids were opened for the COTTONWOOD DRIVE PAVING PROJECT. Seven bids were received. The results of the bidding are shown on the enclosed Bid Tabulation. We have checked the bids and found no errors.

The project entails removing the remaining existing asphalt on Cottonwood Drive (following the waterline replacement project), repairing any soft spots, grading, and paving with new asphalt. The bid included an alternate item to allow an anti-stripping agent other than the city mix design standard of 1% Lime Slurry. This was done to potentially reduce costs. The performance of other anti-strip agents vs. the lime slurry is debatable. Some feel that lime is better, and others feel that there are other products that perform just as well but are not as difficult to work with as lime. After having discussed the matter at length with Mark Larsen and others, it was felt that the savings were not enough to justify doing something different.

After reviewing all bids, we therefore recommend that the Council award the project to **POST CONSTRUCTION COMPANY** with their low bid of **\$221,040.00**. This recommendation is also based upon the contractor's experience and a proven history of quality work for the City.

If the Council agrees with this recommendation, please pass a motion accepting the bid and awarding the project contract to POST CONSTRUCTION COMPANY with their respective bid. We will provide the Notice of Award and Contract Agreement for the City and Contractors to sign. In addition to these documents, the contractor is also responsible to submit Performance and Payment Bonds, and Insurance Certificates within 10 days following Notice of Award.

When these documents have been received, we will schedule a Preconstruction Conference. At this conference we will issue a Notice to Proceed and discuss the construction details with the contractor prior to beginning the work. The date for Substantial Completion is June 30, 2021.

BID TABULATION

South Weber City Cottonwood Drive Paving Project

Bid Opening: March 25, 2021, 2:00 pm, Virtual thru Zoom

Item	Description	Qty	Unit	ENGINEER'S ESTIMATE		Post Construction Company		Staker Parson Companies		Green Construction, Inc.		Kilgore Contracting		Advanced Paving and Construction, LLC		Geneva Rock Products, Inc.		Granite Construction Company	
				Unit Price	Total	Unit Price	Total	Unit Price	Total	Unit Price	Total	Unit Price	Total	Unit Price	Total	Unit Price	Total	Unit Price	Total
Base Bid Schedule																			
1	Mobilization		1 LS	\$ 10,000.00	\$ 10,000.00	\$ 5,000.00	\$ 5,000.00	\$ 11,000.00	\$ 11,000.00	\$ 8,200.00	\$ 8,200.00	\$ 4,500.00	\$ 4,500.00	\$ 3,777.00	\$ 3,777.00	\$ 18,500.00	\$ 18,500.00	\$ 68,000.00	\$ 68,000.00
2	Traffic control		1 LS	\$ 5,000.00	\$ 5,000.00	\$ 500.00	\$ 500.00	\$ 5,000.00	\$ 5,000.00	\$ 2,225.00	\$ 2,225.00	\$ 3,100.00	\$ 3,100.00	\$ 3,100.00	\$ 3,100.00	\$ 4,100.00	\$ 4,100.00	\$ 4,082.50	\$ 4,082.50
3	Asphalt sawcut (2"-3" thick)	180	lf	\$ 2.00	\$ 360.00	\$ 1.00	\$ 180.00	\$ 2.35	\$ 423.00	\$ 2.00	\$ 360.00	\$ 1.30	\$ 234.00	\$ 1.10	\$ 198.00	\$ 2.00	\$ 360.00	\$ 4.00	\$ 720.00
4	Remove existing asphalt (2"-3" thick)	84,000	sf	\$ 0.60	\$ 50,400.00	\$ 0.12	\$ 10,080.00	\$ 0.14	\$ 11,760.00	\$ 0.18	\$ 15,120.00	\$ 0.24	\$ 20,160.00	\$ 0.20	\$ 16,800.00	\$ 0.25	\$ 21,000.00	\$ 0.25	\$ 21,000.00
5	Excavate and remove unsuitable material	170	cy	\$ 50.00	\$ 8,500.00	\$ 25.00	\$ 4,250.00	\$ 53.30	\$ 9,061.00	\$ 22.70	\$ 3,859.00	\$ 27.60	\$ 4,692.00	\$ 12.50	\$ 2,125.00	\$ 28.75	\$ 4,887.50	\$ 34.25	\$ 5,822.50
6	New granular borrow (thickness varies)	210	ton	\$ 38.00	\$ 7,980.00	\$ 25.00	\$ 5,250.00	\$ 32.50	\$ 6,825.00	\$ 22.00	\$ 4,620.00	\$ 27.00	\$ 5,670.00	\$ 18.00	\$ 3,780.00	\$ 26.75	\$ 5,617.50	\$ 28.50	\$ 5,985.00
7	New UTBC (thickness varies)	1,500	ton	\$ 28.00	\$ 42,000.00	\$ 22.50	\$ 33,750.00	\$ 22.00	\$ 33,000.00	\$ 17.00	\$ 25,500.00	\$ 20.00	\$ 30,000.00	\$ 16.80	\$ 25,200.00	\$ 23.00	\$ 34,500.00	\$ 21.50	\$ 32,250.00
8	New stabilization fabric	3,000	sf	\$ 1.00	\$ 3,000.00	\$ 0.30	\$ 900.00	\$ 0.50	\$ 1,500.00	\$ 0.29	\$ 870.00	\$ 0.40	\$ 1,200.00	\$ 0.20	\$ 600.00	\$ 0.25	\$ 750.00	\$ 0.10	\$ 300.00
9	New HMA – 4" thick (approx. 84,000 sf)	2,400	ton	\$ 75.00	\$ 180,000.00	\$ 64.50	\$ 154,800.00	\$ 57.30	\$ 137,520.00	\$ 64.60	\$ 155,040.00	\$ 62.00	\$ 148,800.00	\$ 76.00	\$ 182,400.00	\$ 67.00	\$ 160,800.00	\$ 64.00	\$ 153,600.00
10	Raise valve to grade with concrete collar	6	ea	\$ 500.00	\$ 3,000.00	\$ 550.00	\$ 3,300.00	\$ 400.00	\$ 2,400.00	\$ 800.00	\$ 4,800.00	\$ 565.00	\$ 3,390.00	\$ 425.00	\$ 2,550.00	\$ 450.00	\$ 2,700.00	\$ 720.00	\$ 4,320.00
11	New 4" pavement striping (lane delineation and centerline)	6,700	lf	\$ 0.80	\$ 5,360.00	\$ 0.40	\$ 2,680.00	\$ 0.52	\$ 3,484.00	\$ 0.56	\$ 3,752.00	\$ 0.55	\$ 3,685.00	\$ 0.40	\$ 2,680.00	\$ 0.60	\$ 4,020.00	\$ 0.25	\$ 1,675.00
12	New 12" pavement striping (stop bar)	40	lf	\$ 5.00	\$ 200.00	\$ 3.75	\$ 150.00	\$ 5.25	\$ 210.00	\$ 5.60	\$ 224.00	\$ 5.25	\$ 210.00	\$ 5.60	\$ 224.00	\$ 6.00	\$ 240.00	\$ 10.00	\$ 400.00
13	New pavement symbol (turn arrow)	4	ea	\$ 50.00	\$ 200.00	\$ 50.00	\$ 200.00	\$ 62.95	\$ 251.80	\$ 67.00	\$ 268.00	\$ 65.00	\$ 260.00	\$ 110.00	\$ 440.00	\$ 75.00	\$ 300.00	\$ 55.00	\$ 220.00
TOTAL (Items 1-13)				\$316,000.00		\$221,040.00		\$222,434.80		\$224,838.00		\$225,901.00		\$243,874.00		\$257,775.00		\$298,375.00	

Item	Description	Qty	Unit	ENGINEER'S ESTIMATE		Staker Parson Companies		Post Construction Company		Kilgore Contracting		Green Construction		Advanced Paving and Contracting		Geneva Rock Products, Inc.		Granite Construction Company	
				Unit Price	Total	Unit Price	Total	Unit Price	Total	Unit Price	Total	Unit Price	Total	Unit Price	Total	Unit Price	Total	Unit Price	Total
Bid Schedule w/ Alternate																			
1	Mobilization		1 LS	\$ 10,000.00	\$ 10,000.00	\$ 11,000.00	\$ 11,000.00	\$ 5,000.00	\$ 5,000.00	\$ 4,500.00	\$ 4,500.00	\$ 8,200.00	\$ 8,200.00	\$ 3,777.00	\$ 3,777.00	\$ 18,500.00	\$ 18,500.00	\$ 68,000.00	\$ 68,000.00
2	Traffic control		1 LS	\$ 5,000.00	\$ 5,000.00	\$ 5,000.00	\$ 5,000.00	\$ 500.00	\$ 500.00	\$ 3,100.00	\$ 3,100.00	\$ 2,225.00	\$ 2,225.00	\$ 3,100.00	\$ 3,100.00	\$ 4,100.00	\$ 4,100.00	\$ 4,082.50	\$ 4,082.50
3	Asphalt sawcut (2"-3" thick)	180	lf	\$ 2.00	\$ 360.00	\$ 2.35	\$ 423.00	\$ 1.00	\$ 180.00	\$ 1.30	\$ 234.00	\$ 2.00	\$ 360.00	\$ 1.10	\$ 198.00	\$ 2.00	\$ 360.00	\$ 4.00	\$ 720.00
4	Remove existing asphalt (2"-3" thick)	84,000	sf	\$ 0.60	\$ 50,400.00	\$ 0.14	\$ 11,760.00	\$ 0.12	\$ 10,080.00	\$ 0.24	\$ 20,160.00	\$ 0.18	\$ 15,120.00	\$ 0.20	\$ 16,800.00	\$ 0.25	\$ 21,000.00	\$ 0.25	\$ 21,000.00
5	Excavate and remove unsuitable material	170	cy	\$ 50.00	\$ 8,500.00	\$ 53.30	\$ 9,061.00	\$ 25.00	\$ 4,250.00	\$ 27.60	\$ 4,692.00	\$ 22.70	\$ 3,859.00	\$ 12.50	\$ 2,125.00	\$ 28.75	\$ 4,887.50	\$ 34.25	\$ 5,822.50
6	New granular borrow (thickness varies)	210	ton	\$ 38.00	\$ 7,980.00	\$ 32.50	\$ 6,825.00	\$ 25.00	\$ 5,250.00	\$ 27.00	\$ 5,670.00	\$ 22.00	\$ 4,620.00	\$ 18.00	\$ 3,780.00	\$ 26.75	\$ 5,617.50	\$ 28.50	\$ 5,985.00
7	New UTBC (thickness varies)	1,500	ton	\$ 28.00	\$ 42,000.00	\$ 22.00	\$ 33,000.00	\$ 22.50	\$ 33,750.00	\$ 20.00	\$ 30,000.00	\$ 17.00	\$ 25,500.00	\$ 16.80	\$ 25,200.00	\$ 23.00	\$ 34,500.00	\$ 21.50	\$ 32,250.00
8	New stabilization fabric	3,000	sf	\$ 1.00	\$ 3,000.00	\$ 0.50	\$ 1,500.00	\$ 0.30	\$ 900.00	\$ 0.40	\$ 1,200.00	\$ 0.29	\$ 870.00	\$ 0.20	\$ 600.00	\$ 0.25	\$ 750.00	\$ 0.10	\$ 300.00
A-1	New HMA – 4" thick (approx. 84,000 sf) w/ equal alternate anti-strip agent other than 1% Lime Slurry	2,400	ton	\$ 71.00	\$ 170,400.00	\$ 55.30	\$ 132,720.00	\$ 64.50	\$ 154,800.00	\$ 62.00	\$ 148,800.00	\$ 68.60	\$ 164,640.00	\$ 76.00	\$ 182,400.00	\$ 64.85	\$ 155,640.00	\$ 64.00	\$ 153,600.00
10	Raise valve to grade with concrete collar	6	ea	\$ 500.00	\$ 3,000.00	\$ 400.00	\$ 2,400.00	\$ 550.00	\$ 3,300.00	\$ 565.00	\$ 3,390.00	\$ 800.00	\$ 4,800.00	\$ 425.00	\$ 2,550.00	\$ 450.00	\$ 2,700.00	\$ 720.00	\$ 4,320.00
11	New 4" pavement striping (lane delineation and centerline)	6,700	lf	\$ 0.80	\$ 5,360.00	\$ 0.52	\$ 3,484.00	\$ 0.40	\$ 2,680.00	\$ 0.55	\$ 3,685.00	\$ 0.56	\$ 3,752.00	\$ 0.40	\$ 2,680.00	\$ 0.60	\$ 4,020.00	\$ 0.25	\$ 1,675.00
12	New 12" pavement striping (stop bar)	40	lf	\$ 5.00	\$ 200.00	\$ 5.25	\$ 210.00	\$ 3.75	\$ 150.00	\$ 5.25	\$ 210.00	\$ 5.60	\$ 224.00	\$ 5.60	\$ 224.00	\$ 6.00	\$ 240.00	\$ 10.00	\$ 400.00
13	New pavement symbol (turn arrow)	4	ea	\$ 50.00	\$ 200.00	\$ 62.95	\$ 251.80	\$ 50.00	\$ 200.00	\$ 65.00	\$ 268.00	\$ 67.00	\$ 268.00	\$ 110.00	\$ 440.00	\$ 75.00	\$ 300.00	\$ 55.00	\$ 220.00
ALTERNATE TOTAL (Items 1-13, Substitute A-1 for 9)				\$306,400.00		\$217,634.80		\$221,040.00		\$225,901.00		\$234,438.00		\$243,874.00		\$252,615.00		\$298,375.00	

Project Engineer 

Date 3/25/2021

RESOLUTION 21-22
A RESOLUTION OF THE SOUTH WEBER CITY COUNCIL AWARDING
COTTONWOOD DRIVE PAVING PROJECT CONTRACT

WHEREAS, Cottonwood Drive was identified as needing major road maintenance; and

WHEREAS, the Cottonwood waterline had to be completed prior to repair; and

WHEREAS, the work on the joint waterline has been completed; and

WHEREAS, bids were advertised per state requirements and were opened by City Engineer, Jones and Associates on March 25, 2021; and

WHEREAS, seven bids were received and tabulated; and

WHEREAS, based on bid amount and contractor’s proven history of quality work for the city, Engineer Brandon Jones has recommended acceptance of the bid from Post Construction in the amount of \$ 221,040.00;

NOW THEREFORE BE IT RESOLVED by the Council of South Weber City, Davis County, State of Utah, as follows:

Section 1. Award: The Cottonwood Drive Paving Project is hereby awarded to Post Construction Company in the amount of \$221,040.00

Section 2: Repealer Clause: All ordinances or resolutions or parts thereof, which are in conflict herewith, are hereby repealed.

PASSED AND ADOPTED by the City Council of South Weber, Davis County, on the 13th day of April 2021.

Roll call vote is as follows:		
Council Member Winsor	FOR	AGAINST
Council Member Petty	FOR	AGAINST
Council Member Soderquist	FOR	AGAINST
Council Member Alberts	FOR	AGAINST
Council Member Halverson	FOR	AGAINST

Jo Sjoblom, Mayor

Attest: Lisa Smith, Recorder

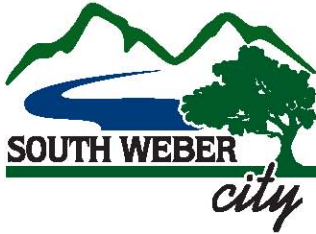

Agenda Item Introduction

Council Meeting Date: 04-13-2021

Name: Lisa Smith

Agenda Item: Riverside RV Park Development Agreement Amendment

Background: On March 9, 2021 Riverside requested two amendments to the development agreement recorded on 11-05-2020 1) landscaping variation and 2) fencing change. The Council agreed on the change to the fencing to a sound wall but requested changes to the proposed landscaping. The developer is bringing back the modified plan for approval.

Summary: Review landscape plan

Budget Amendment: na

Procurement Officer Review: Budgeted amount \$ Bid amount \$

Committee Recommendation: na

Planning Commission Recommendation: na

Staff Recommendation: na

Attachments: Proposed landscape plan
 Resolution 21-20
 Amended development agreement

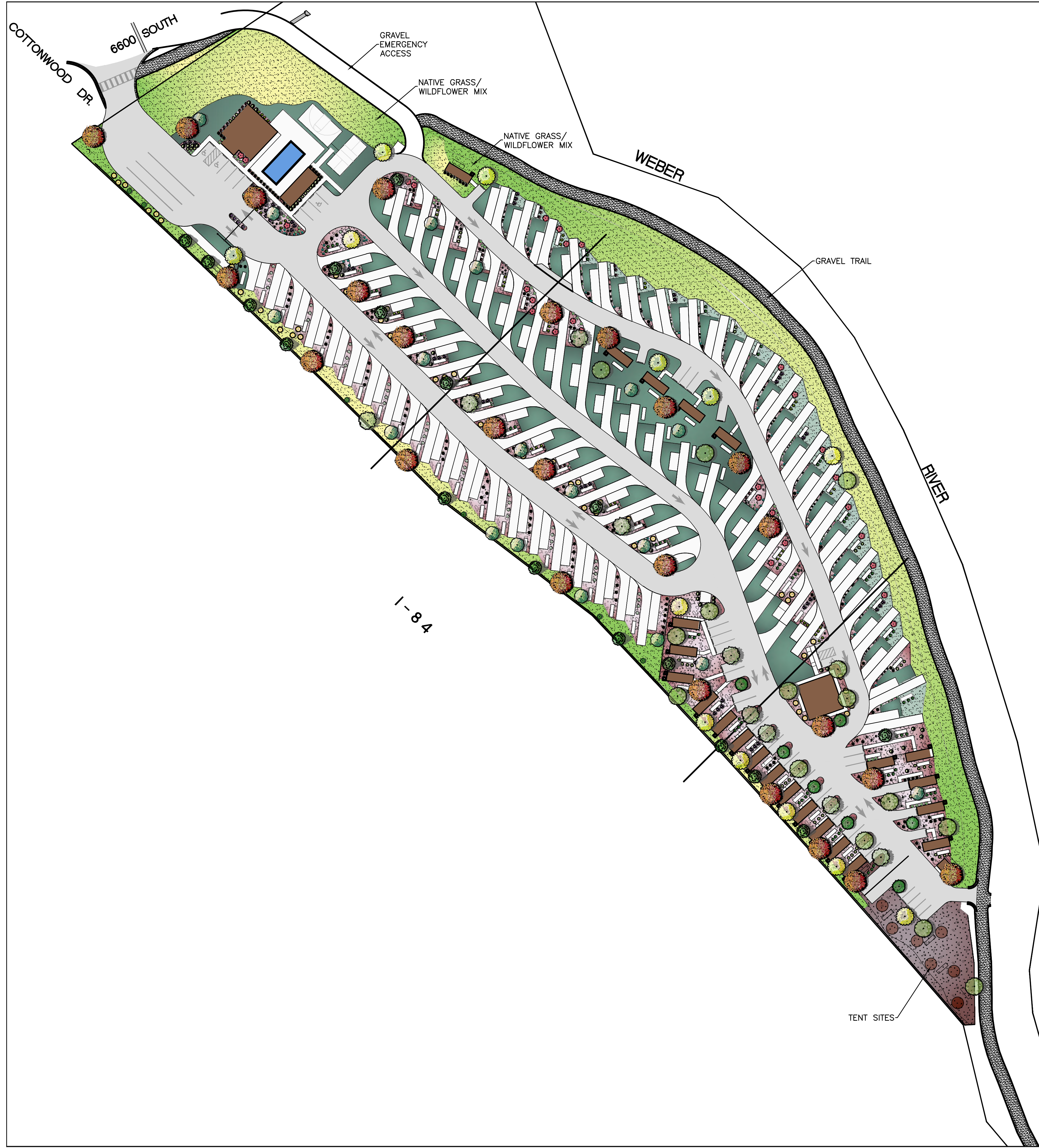

PLANT SCHEDULE					
TREES	QTY	COMMON / BOTANICAL NAME	CONT	CAL	SIZE
	15	American Hornbeam / <i>Carpinus caroliniana</i>	B&B	1.5"	Cal
	25	Autumn Blaze Maple / <i>Acer freemanii</i> 'Autumn Blaze'	B&B	1.5"	Cal
	7	Emerald Queen Maple / <i>Acer platanoides</i> 'Emerald Queen'	B&B	1.5"	Cal
	13	Maidenhair Tree / <i>Ginkgo biloba</i> 'Autumn Gold' TM	B&B	1.5"	Cal
	18	River Birch / <i>Betula nigra</i>	B&B	1.5"	Cal
	9	Shademaster Locust / <i>Gleditsia triacanthos inermis</i> 'Shademaster' TM	B&B	1.5"	Cal
EVERGREEN TREES	QTY	COMMON / BOTANICAL NAME	CONT	CAL	SIZE
	17	Austrian Pine / <i>Pinus nigra</i>	B&B		6'
	8	Emerald Green Arborvitae / <i>Thuja occidentalis</i> 'Smaragd'	B&B		4'
SHRUBS	QTY	COMMON / BOTANICAL NAME	CONT		
	52	Black Lace Elderberry / <i>Sambucus nigra</i> 'Black Lace'	2 gal		
	39	Blue Mist Shrub / <i>Caryopteris x clandonensis</i> 'Dark Knight'	2 gal		
	33	Creeping Mahonia / <i>Mahonia repens</i>	2 gal		
	13	Dwarf Korean Lilac / <i>Syringa meyeri</i> 'Palibin'	2 gal		
	47	Dwarf Variegated Dogwood / <i>Cornus alba</i> 'Variegata'	2 gal		
	86	Fine Line Buchthorn / <i>Rhamnus frangula</i> 'Fine Line'	2 gal		
	51	Gro-Low Fragrant Sumac / <i>Rhus aromatica</i> 'Gro-Low'	2 gal		
	46	Japanese Spirea / <i>Spiraea japonica</i> 'Anthony Waterer'	2 gal		
	47	Mugo Pine / <i>Pinus mugo</i> 'Slowmound'	2 gal		
	59	Northern Gold Forsythia / <i>Forsythia x 'Northern Gold'</i>	2 gal		
	31	Purple Leaf Sand Cherry / <i>Prunus x cistena</i>	2 gal		
	30	Red Leaf Japanese Barberry / <i>Berberis thunbergii</i> 'Atropurpurea'	2 gal		
	52	Spirea / <i>Spiraea japonica</i> 'Goldmound'	2 gal		
ANNUALS/PERENNIALS	QTY	COMMON / BOTANICAL NAME	CONT		
	51	Emerald Blue Moss Phlox / <i>Phlox subulata</i> 'Emerald Blue'	1 gal		
	29	Stella de Oro Daylily / <i>Hemerocallis x 'Stella de Oro'</i>	1 gal		
	47	Stonecrop / <i>Sedum spurium</i> 'Red Carpet'	1 gal		
	41	Variegated Goutweed / <i>Aegopodium podagraria</i> 'Variegatum'	1 gal		
GRASSES	QTY	COMMON / BOTANICAL NAME	CONT		
	52	Blue Oat Grass / <i>Helictotrichon sempervirens</i>	1 gal		
	162	Feather Reed Grass / <i>Calamagrostis x acutiflora</i> 'Karl Foerster'	1 gal		
GROUND COVERS	QTY	COMMON / BOTANICAL NAME	CONT		
	9,455 sf	(Owner Supplied wood mulch) / 4" Wood Mulch W/Dewitt Pro-5 Weed Barrier	Mulch		
	47,466 sf	2"-4" Nephi Cobble Rock / 2"-4" Nephi Cobble Rock W/Dewitt Pro-5 Weed Barrier or Nephi Pea Gravel or Chat	Mulch		
	45,662 sf	Fine Fescue / <i>Festuca</i> spp.	Hydroseed		
	8,276 sf	Grey Chat / 4" Grey Chat	Mulch		
	66,528 sf	Native Grass & Wildflower Mix / Or Other Drought Tolerant Grass	Hydroseed		

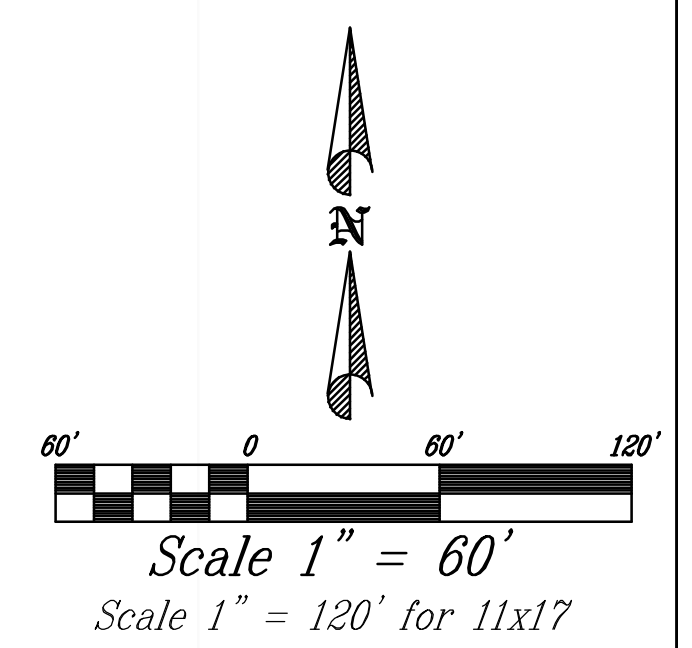

THIS DOCUMENT IS RELEASED FOR REVIEW ONLY. IT IS NOT INTENDED FOR CONSTRUCTION UNLESS SIGNED AND SEALED.

CARL N. BERG L.A.
SERIAL NO. 7162790
DATE: 30_MAR_2021

EDGING NOTE:
INSTALL METAL EDGING AT ANY LOCATION WHERE NATIVE GRASS MEETS OTHER MATERIALS.

EXISTING TREE NOTE:
TREE WILL NOT BE PLANTED IN AREAS WHERE EXISTING TREES REMAIN NEARBY.

MCKAY WINKEL
SOUTH WEBER RV PARK

SITE PLAN

380 E Main St, Suite 204
Midway, Ut 84049 ph. (801) 723-2000

DESIGN BY: CNB DATE: 26 MAR 2021 SHEET L1
DRAWN BY: CNB REV:



Scale 1" = 20'
Scale 1" = 40' for 11x17

PLANT SCHEDULE L02				
TREES	QTY	COMMON / BOTANICAL NAME	CONT	CAL
	8	Autumn Blaze Maple / Acer freemanii 'Autumn Blaze'	8&B	1.5' Cal
	4	Maidenhair Tree / Ginkgo biloba 'Autumn Gold' TM	8&B	1.5' Cal
	7	River Birch / Betula nigra	8&B	1.5' Cal
	1	Shademaster Locust / Gleditsia tricanthos inermis 'Shademaster' TM	8&B	1.5' Cal
EVERGREEN TREES	QTY	COMMON / BOTANICAL NAME	CONT	CAL
	8	Austrian Pine / Pinus nigra	8&B	
	3	Emerald Green Arborvitae / Thuja occidentalis 'Smaragd'	8&B	
SHRUBS	QTY	COMMON / BOTANICAL NAME	CONT	
	24	Black Lace Elderberry / Sambucus nigra 'Black Lace'	2 gal	
	15	Blue Mist Shrub / Caryopteris x clandonensis 'Dark Knight'	2 gal	
	7	Creeping Mahonia / Mahonia repens	2 gal	
	13	Dwarf Korean Lilac / Syringa meyeri 'Palibin'	2 gal	
	22	Dwarf Variegated Dogwood / Cornus alba 'Variegata'	2 gal	
	11	Fine Line Buchthorn / Rhamnus frangula 'Fine Line'	2 gal	
	19	Gro-Low Fragrant Sumac / Rhus aromatica 'Gro-Low'	2 gal	
	13	Japanese Spirea / Spiraea japonica 'Anthony Waterer'	2 gal	
	31	Mugo Pine / Pinus mugo 'Stowmound'	2 gal	
	27	Northern Gold Forsythia / Forsythia x 'Northern Gold'	2 gal	
	11	Purple Leaf Sand Cherry / Prunus x cistena	2 gal	
	16	Red Leaf Japanese Barberry / Berberis thunbergii 'Atropurpurea'	2 gal	
	23	Spiraea / Spiraea japonica 'Goldmound'	2 gal	
ANNUALS/PERENNIALS	QTY	COMMON / BOTANICAL NAME	CONT	
	10	Emerald Blue Moss Phlox / Phlox subulata 'Emerald Blue'	1 gal	
	3	Stella de Oro Daylily / Hemerocallis x 'Stella de Oro'	1 gal	
	12	Stoncrop / Sedum spurium 'Red Carpet'	1 gal	
	6	Variegated Goutweed / Aegopodium podagraria 'Variegatum'	1 gal	
GRASSES	QTY	COMMON / BOTANICAL NAME	CONT	
	19	Blue Oat Grass / Helictotrichon sempervirens	1 gal	
	68	Feather Reed Grass / Calamagrostis x acutiflora 'Karl Foerster'	1 gal	
GROUND COVERS	QTY	COMMON / BOTANICAL NAME	CONT	
	12,296 sf	2"-4" Nepheli Cobble Rock / 2"-4" Nepheli Cobble Rock W/Dewitt Pro-5 Weed Barrier or Nepheli Peas Gravel or Chat	Mulch	
	13,854 sf	Fine Fescue / Festuca spp.	Hydroseed	
	818 sf	Grey Chat / 4" Grey Chat	Mulch	
	18,408 sf	Native Grass & Wildflower Mix / Or Other Drought Tolerant Grass	Hydroseed	

THIS DOCUMENT IS RELEASED FOR REVIEW ONLY. IT IS NOT INTENDED FOR CONSTRUCTION UNLESS SIGNED AND SEALED.
CARL N. BERG L.A.
SERIAL NO. 7162790
DATE: 30 MAR 2021

MCKAY WINKEL
SOUTH WEBER RV PARK

PLANTING PLAN

380 E Main St, Suite 204
Midway, Ut 84049 ph. (801) 723-2000

DESIGN BY: CNB	DATE: 30 MAR 2021	SHEET
DRAWN BY: CNB	REV:	L2

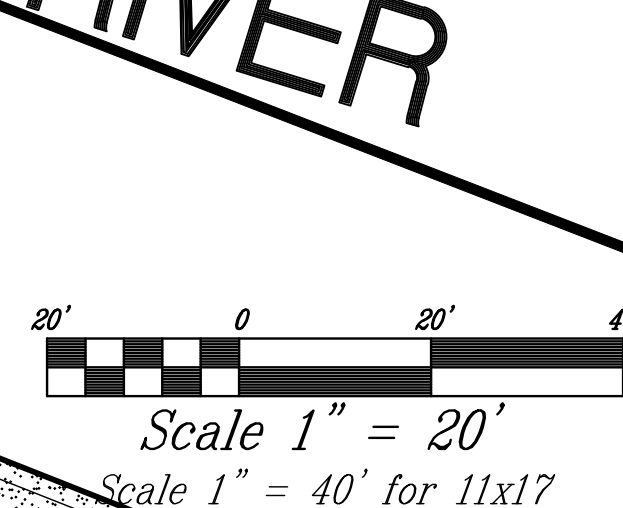
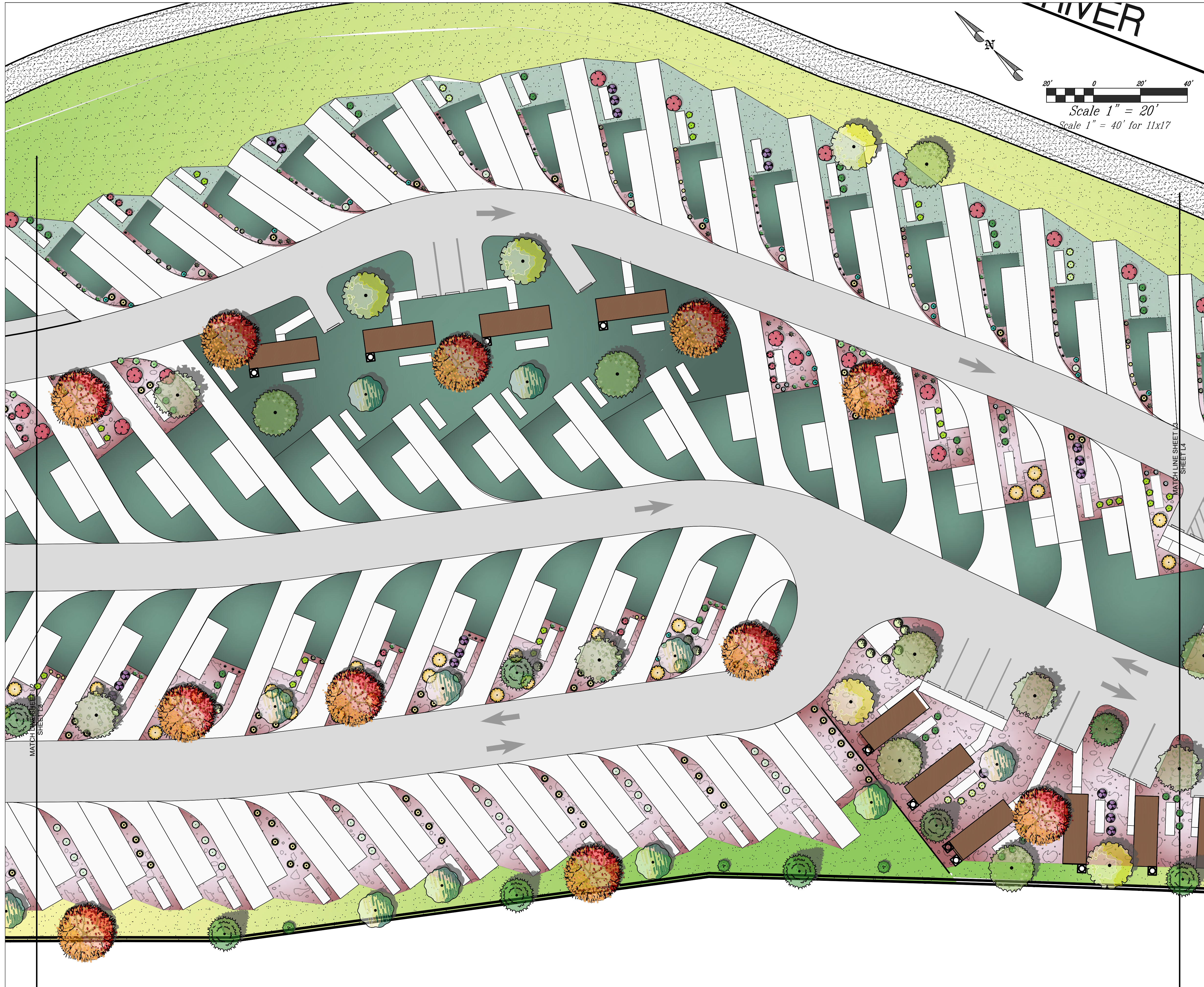

PLANT SCHEDULE L03

TREES	QTY	COMMON / BOTANICAL NAME	CONT	CAL
	6	American Hornbeam / <i>Carpinus caroliniana</i>	B&B	1.5" Cal
	11	Autumn Blaze Maple / <i>Acer freemanii</i> 'Autumn Blaze'	B&B	1.5" Cal
	1	Emerald Queen Maple / <i>Acer platanoides</i> 'Emerald Queen'	B&B	1.5" Cal
	5	Maidenhair Tree / <i>Ginkgo biloba</i> 'Autumn Gold' TM	B&B	1.5" Cal
	10	River Birch / <i>Betula nigra</i>	B&B	1.5" Cal
	5	Shademaster Locust / <i>Gleditsia triacanthos inermis</i> 'Shademaster' TM	B&B	1.5" Cal
EVERGREEN TREES	QTY	COMMON / BOTANICAL NAME	CONT	CAL
	5	Austrian Pine / <i>Pinus nigra</i>	B&B	
	3	Emerald Green Arborvitae / <i>Thuja occidentalis</i> 'Smaragd'	B&B	
SHRUBS	QTY	COMMON / BOTANICAL NAME	CONT	
	21	Black Lace Elderberry / <i>Sambucus nigra</i> 'Black Lace'	2 gal	
	8	Blue Mist Shrub / <i>Caryopteris x dandonensis</i> 'Dark Knight'	2 gal	
	20	Creeping Mahonia / <i>Mahonia repens</i>	2 gal	
	14	Dwarf Variegated Dogwood / <i>Cornus alba</i> 'Variegata'	2 gal	
	43	Fine Line Buchthorn / <i>Rhamnus frangula</i> 'Fine Line'	2 gal	
	31	Gro-Low Fragrant Sumac / <i>Rhus aromatica</i> 'Gro-Low'	2 gal	
	9	Japanese Spirea / <i>Spiraea japonica</i> 'Anthony Waterer'	2 gal	
	9	Mugo Pine / <i>Pinus mugo</i> 'Stowmound'	2 gal	
	25	Northern Gold Forsythia / <i>Forsythia x 'Northern Gold'</i>	2 gal	
	18	Purple Leaf Sand Cherry / <i>Prunus x cistena</i>	2 gal	
	12	Red Leaf Japanese Barberry / <i>Berberis thunbergii</i> 'Atropurpurea'	2 gal	
	29	Spiraea / <i>Spiraea japonica</i> 'Goldmound'	2 gal	
ANNUALS/PERENNIALS	QTY	COMMON / BOTANICAL NAME	CONT	
	33	Emerald Blue Moss Phlox / <i>Phlox subulata</i> 'Emerald Blue'	1 gal	
	26	Stella de Oro Daylily / <i>Hemerocallis x 'Stella de Oro'</i>	1 gal	
	32	Stoncrop / <i>Sedum spuriatum</i> 'Red Carpet'	1 gal	
	27	Variegated Goutweed / <i>Aegopodium podagraria</i> 'Variegatum'	1 gal	
GRASSES	QTY	COMMON / BOTANICAL NAME	CONT	
	31	Blue Oat Grass / <i>Helictotrichon sempervirens</i>	1 gal	
	60	Feather Reed Grass / <i>Calamagrostis x acutiflora</i> 'Karl Foerster'	1 gal	
GROUND COVERS	QTY	COMMON / BOTANICAL NAME	CONT	
	22,789 sf	2"-4" Nepheli Cobble Rock / 2"-4" Nepheli Cobble Rock W/Dewitt Pro-5 Weed Barrier or Nepheli Pea Gravel or Chat	Mulch	
	30,535 sf	Fine Fescue / <i>Festuca</i> spp.	Hydroseed	
	5,779 sf	Grey Chat / 4" Grey Chat	Mulch	
	12,918 sf	Native Grass & Wildflower Mx / Or Other Drought Tolerant Grass	Hydroseed	

THIS DOCUMENT IS RELEASED FOR REVIEW ONLY. IT IS NOT INTENDED FOR CONSTRUCTION UNLESS SIGNED AND SEALED.

CARL N. BERG L.A.
 SERIAL NO. 7162790
 DATE: 30 MAR 2021

MCKAY WINKEL
SOUTH WEBER RV PARK

PLANTING PLAN

380 E Main St, Suite 204
Midway, Ut 84049 ph. (801) 723-2000

DESIGN BY: CNB	DATE: 26 MAR 2021
DRAWN BY: CNB	REV:

SHEET L3

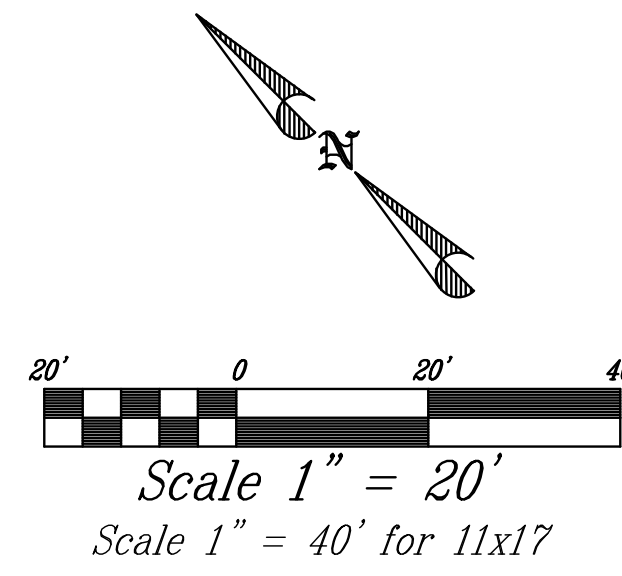

PLANT SCHEDULE L04

TREES	QTY	COMMON / BOTANICAL NAME	CONT	CAL
	9	American Hornbeam / <i>Carpinus caroliniana</i>	B&B	1.5' Cal
	6	Autumn Blaze Maple / <i>Acer freemanii</i> 'Autumn Blaze'	B&B	1.5' Cal
	6	Emerald Queen Maple / <i>Acer platanoides</i> 'Emerald Queen'	B&B	1.5' Cal
	4	Maidenhair Tree / <i>Ginkgo biloba</i> 'Autumn Gold'™	B&B	1.5' Cal
	1	River Birch / <i>Betula nigra</i>	B&B	1.5' Cal
	3	Shademaster Locust / <i>Gleditsia triacanthos inermis</i> 'Shademaster'™	B&B	1.5' Cal
EVERGREEN TREES	QTY	COMMON / BOTANICAL NAME	CONT	CAL
	4	Austrian Pine / <i>Pinus nigra</i>	B&B	
	2	Emerald Green Arborvitae / <i>Thuja occidentalis</i> 'Smaragd'	B&B	
SHRUBS	QTY	COMMON / BOTANICAL NAME	CONT	
	7	Black Lace Elderberry / <i>Sambucus nigra</i> 'Black Lace'	2 gal	
	16	Blue Mist Shrub / <i>Caryopteris x clandonensis</i> 'Dark Knight'	2 gal	
	6	Creeping Mahonia / <i>Mahonia repens</i>	2 gal	
	11	Dwarf Variegated Dogwood / <i>Cornus alba</i> 'Variegata'	2 gal	
	32	Fine Line Buchthorn / <i>Rhamnus frangula</i> 'Fine Line'	2 gal	
	1	Gro-Low Fragrant Sumac / <i>Rhus aromatica</i> 'Gro-Low'	2 gal	
	23	Japanese Spirea / <i>Spiraea japonica</i> 'Anthony Waterer'	2 gal	
	7	Mugo Pine / <i>Pinus mugo</i> 'Slowmound'	2 gal	
	7	Northern Gold Forsythia / <i>Forsythia x</i> 'Northern Gold'	2 gal	
	2	Purple Leaf Sand Cherry / <i>Prunus x cistena</i>	2 gal	
ANNUALS/PERENNIALS	QTY	COMMON / BOTANICAL NAME	CONT	
	8	Emerald Blue Moss Phlox / <i>Phlox subulata</i> 'Emerald Blue'	1 gal	
	3	Stonecrop / <i>Sedum spurius</i> 'Red Carpet'	1 gal	
	8	Variegated Goutweed / <i>Aegopodium podagraria</i> 'Variegatum'	1 gal	
GRASSES	QTY	COMMON / BOTANICAL NAME	CONT	
	2	Blue Oat Grass / <i>Helictotrichon sempervirens</i>	1 gal	
	34	Feather Reed Grass / <i>Calamagrostis x acutiflora</i> 'Karl Foerster'	1 gal	
GROUND COVERS	QTY	COMMON / BOTANICAL NAME	CONT	
	9,455 sf	(Owner Supplied wood mulch) / 4" Wood Mulch Wildwell Pro-5 Weed Barrier	Mulch	
	12,381 sf	2"-4" Nepheli Cobble Rock / 2"-4" Nepheli Cobble Rock Wildwell Pro-5 Weed Barrier or Nepheli Fine Gravel or Chat	Mulch	
	1,273 sf	Fine Fescue / <i>Festuca</i> spp.	Hydroseed	
	1,679 sf	Grey Chat / 4" Grey Chat	Mulch	
	2,629 sf	Native Grass & Wildflower Mix / Or Other Drought Tolerant Grass	Hydroseed	

THIS DOCUMENT IS RELEASED FOR REVIEW ONLY. IT IS NOT INTENDED FOR CONSTRUCTION UNLESS SIGNED AND SEALED.
 CARL N. BERG L.A.
 SERIAL NO. 7162790
 DATE: 30 MAR 2021

MCKAY WINKEL
SOUTH WEBER RV PARK

PLANTING PLAN

380 E Main St, Suite 204
Midway, Ut 84049 ph. (801) 723-2000

DESIGN BY: CNB	DATE: 26 MAR 2021
DRAWN BY: CNB	REV:

SHEET L4

RESOLUTION 21-23
A RESOLUTION OF THE SOUTH WEBER CITY COUNCIL AMENDING
THE RIVERSIDE RV PARK DEVELOPMENT AGREEMENT

WHEREAS, a development agreement for Riverside RV Park was approved and subsequently recorded on November 5, 2020; and

WHEREAS, the developer requested two changes to the original agreement namely, 1) a change in landscaping plans and 2) a change in fencing on March 9, 2021; and

WHEREAS, Council approved the change to a sound wall but charged the landscaper to make additional changes to the plan; and

WHEREAS, the developer is presenting an alternate landscape proposal; and

WHEREAS, Council is satisfied the landscape will be aesthetically pleasing and appropriate;

NOW THEREFORE BE IT RESOLVED by the Council of South Weber City, Davis County, State of Utah, as follows:

Section 1. Approval: The First Amendment to the Development Agreement for Riverside RV Park in South Weber City presented in Exhibit 1 is hereby approved.

Section 2: Repealer Clause: All ordinances or resolutions or parts thereof, which are in conflict herewith, are hereby repealed.

PASSED AND ADOPTED by the City Council of South Weber, Davis County, on the 13th day of April 2021.

Roll call vote is as follows:		
Council Member Winsor	FOR	AGAINST
Council Member Petty	FOR	AGAINST
Council Member Soderquist	FOR	AGAINST
Council Member Alberts	FOR	AGAINST
Council Member Halverson	FOR	AGAINST

Mayor: Jo Sjoblom

Attest: City Recorder Lisa Smith

EXHIBIT 1

FIRST AMENDMENT TO THE DEVELOPMENT AGREEMENT FOR RIVERSIDE RV PARK IN SOUTH WEBER CITY

**When recorded return to:
South Weber City
1600 East South Weber Drive
South Weber, Utah 84405**

**FIRST AMENDMENT TO THE DEVELOPMENT AGREEMENT
FOR RIVERSIDE RV PARK IN SOUTH WEBER CITY**

This FIRST AMENDMENT to the Development Agreement for the Riverside RV Park in South Weber, Utah, is made an entered into as of this 13th day of April, 2021, by and between F.M. WINKEL FAMILY L.L.C., a Utah limited liability company, having its principal business address as 3651 North 100 East #125, Provo, Utah (hereinafter referred to as “Owner”), and SOUTH WEBER CITY, a municipal corporation of the State of Utah (hereinafter referred to as “City”), of 1600 East South Weber Drive, South Weber, UT 84405. Owner and City are heretofore individually referred to as “Party” or collectively referred to as “Parties”.

RECITALS

WHEREAS, the Parties previously entered into that certain Development Agreement for Riverside RV Park in South Weber City dated June 9, 2020 (“Development Agreement”), providing for the development of a Recreational Vehicle Park within South Weber City; and

WHEREAS, the Owner has proposed certain changes to the landscaping and fencing requirements of the Development Agreement; and

WHEREAS, the Parties have determined that it is in the best interest of the City and its residents and will promote the public welfare to amend certain provisions of the Development Agreement as it relates to landscaping and fencing;

NOW, THEREFORE, in consideration of the mutual covenants contained herein and other good and valuable consideration, the receipt and sufficiency of which are hereby acknowledged, the Parties agree as follows:

Section 1. Amendment. Section 17 of the Development Agreement is hereby amended to read in its entirety as follows:

17. **Landscaping**. All proposed landscaping shall be substantially installed prior to the granting of Occupancy and shall be in accordance with the approved Landscape Plans, dated March 30, 2021, by Berg Landscape Architects. The removal of existing trees and shrubs shall be directed by a licensed or certified arborist.

Section 2. Amendment. Section 19 of the Development Agreement is hereby amended to read in its entirety as follows:

19. **Approval of Setbacks**. City hereby grants Owner and the Property the exception provided in Section 10-7F-2(B)(2) of the City Code to allow trailers, service buildings, or structures to be placed within seventy-five feet (75') but not closer than three feet (3') to the boundary line nearest to or adjoining Interstate 84. In exchange, Developer agrees to construct a barrier along the property line that borders the Interstate 84 right-of-way line. It is agreed that the fencing along the I-84 Right-of-Way line shall not be vinyl nor chain link fencing. The barrier shall consist of an 8' tall solid precast concrete sound wall substantially similar to the wall shown in Exhibit D.

Section 3. Amendment. The Development Agreement is hereby amended to add an Exhibit D, Sound Wall Drawing, attached hereto and incorporated herein by reference.

Section 4. Other Terms and Provisions Not Affected. The other terms and provisions of the Development Agreement shall remain in full force and effect without amendment.

IN WITNESS WHEREOF, the City and Owner have caused this Agreement to be duly executed on or as of the day and year first above written.

[Signature Pages Follow]

“City”

SOUTH WEBER CITY

By: _____
David Larson, City Manager

Attest: Lisa Smith, City Recorder

STATE OF _____)
 :SS
COUNTY OF _____)

Subscribed and sworn to before me on the ____ day of April 2021, by David Larson.

WITNESS my hand and official seal the day and year in this certificate first above written.

Notary Public

EXHIBIT D
SOUND WALL DRAWING

EXHIBIT D

#9 Riverside Landscape Amd

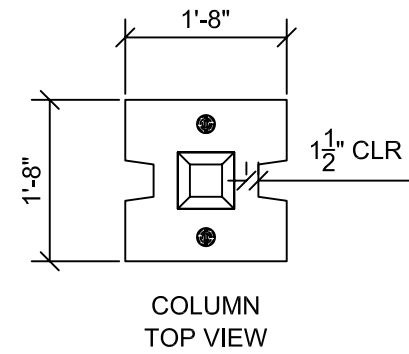

(2) 3/4"Øx6" B-16 COIL LOOP INSERTS W/ 1/2" RECESS

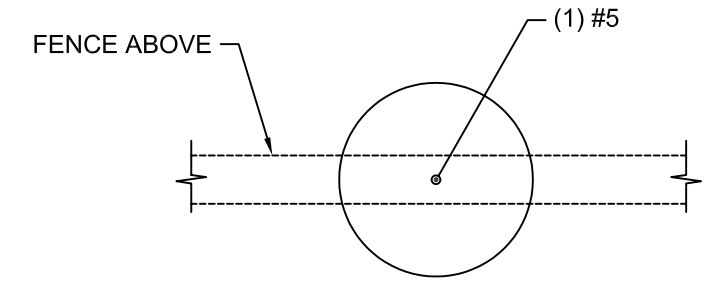
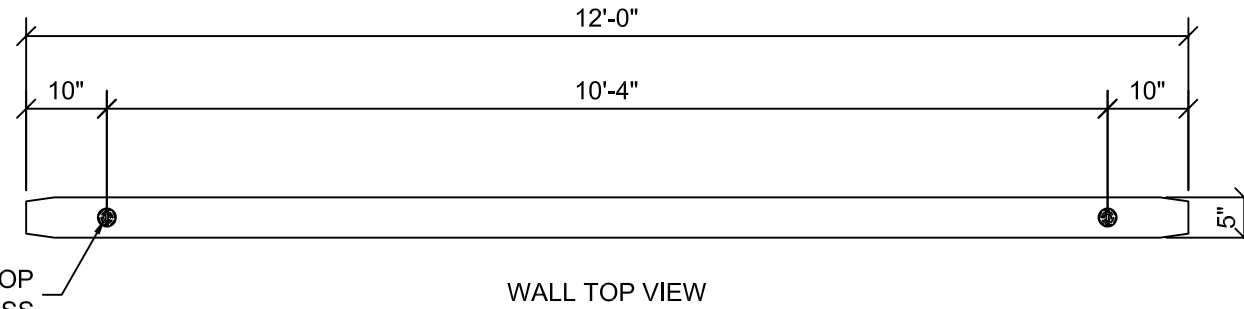

(2) 3/4"Øx6" B-16 COIL LOOP INSERTS W/ 1/2" RECESS
#4 REBAR @ PERIMETER CENTER OF PANEL THICKNESS 1/2" MIN. CLEAR ALL AROUND

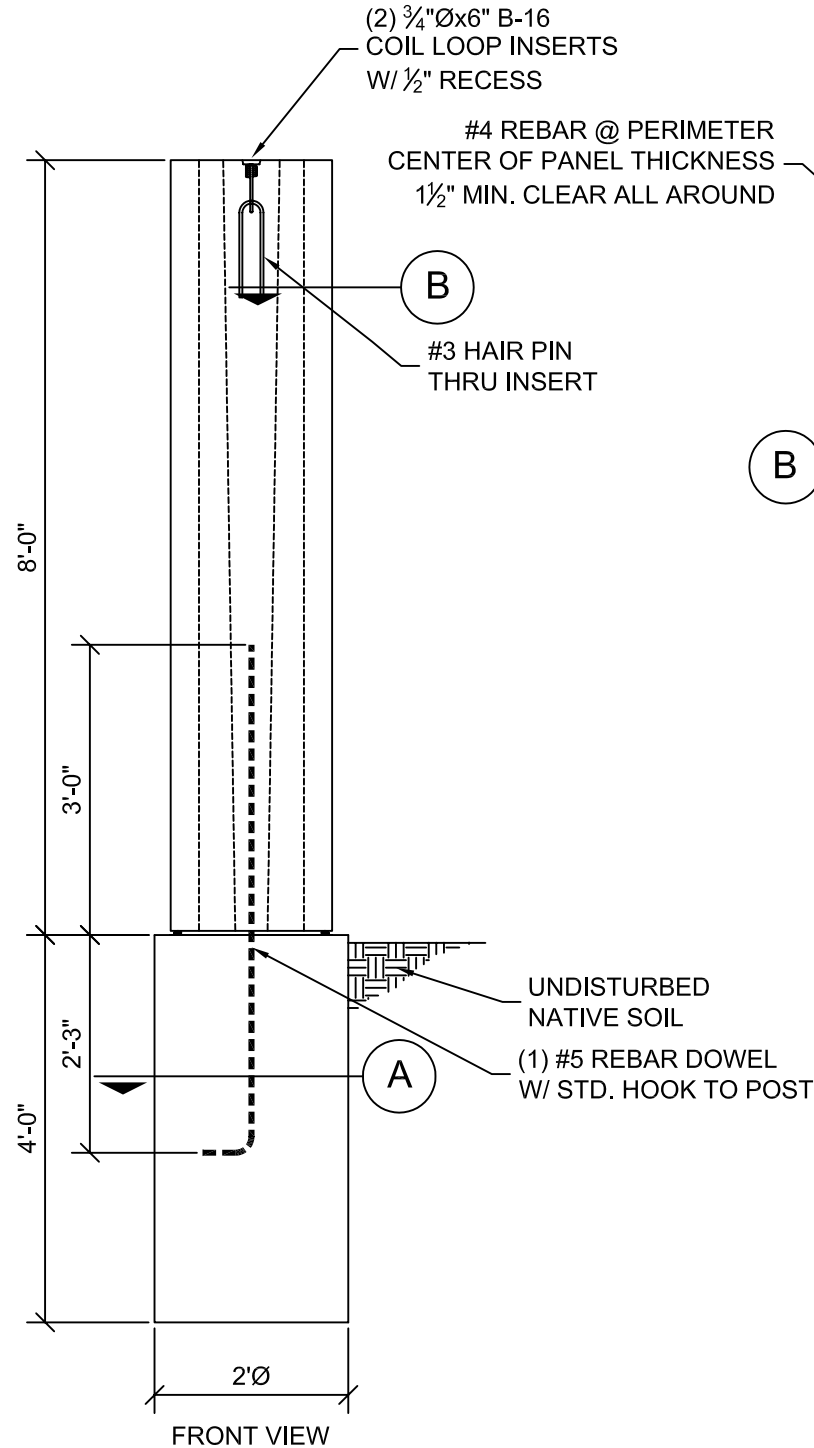
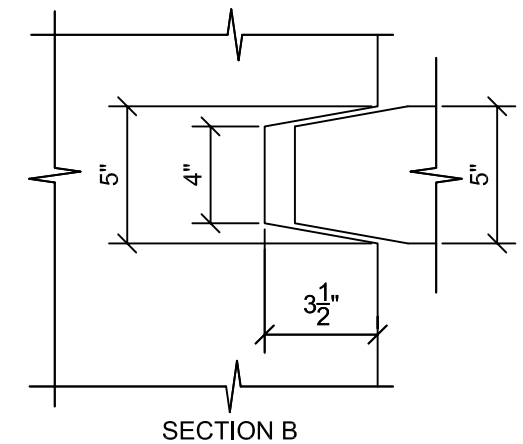
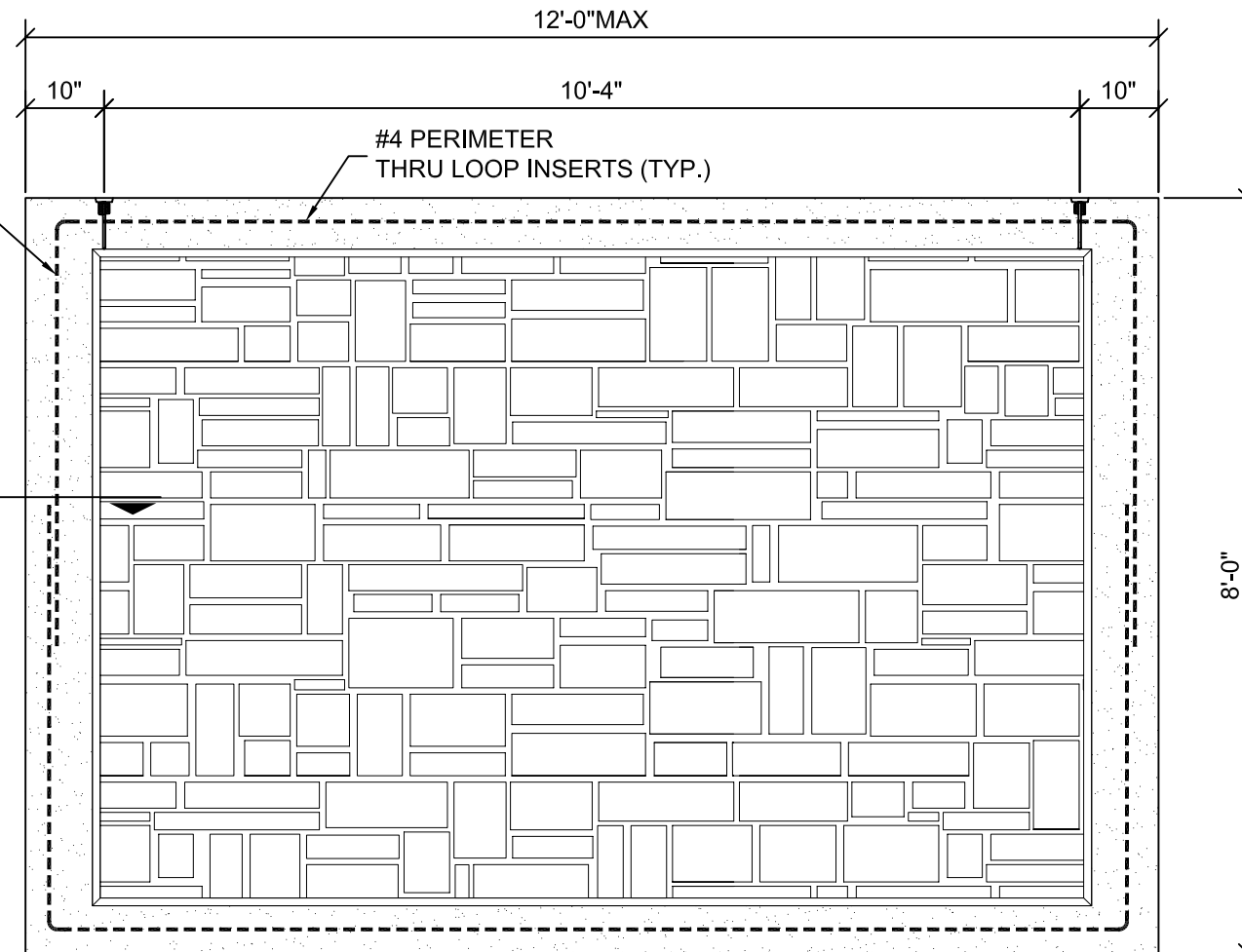

UNDISTURBED NATIVE SOIL
(1) #5 REBAR DOWEL W/ STD. HOOK TO POST

NOTES:

1. POST AND PANEL CONCRETE TO BE 5000 PSI.
2. FOOTING CONCRETE TO BE 3000 PSI.
3. MINIMUM SOIL LATERAL BEARING ALLOWABLE: 150 PSF/FT. OF DEPTH BELOW GRADE
4. MINIMUM ALLOWABLE SOIL BEARING PRESSURE: 2000 PSF.
5. DIMENSIONS MAY BE REDUCED TO FIT PROJECT REQUIREMENTS.
6. GROUT BETWEEN POST AND FOOTING TO BE 2500 PSI.

TYP. 8' PANEL, PIER & POST	
CONCRETE	
$f_c = 5,000$ PSI	$f_{ci} = 2,500$ PSI
SLUMP: 4"-9"	FPU: N/A
FINISH: PATTERN	MIX: TBD
WEIGHT: 150 LBS. PCF.	AIR: 5%
VOLUME: TBD	SHIPPING WT: TBD

OWELL
PRECAST

16500 SOUTH 500 WEST
BLUFFDALE, UTAH 84065
PHONE: (801) 571-5041
FAX: (801) 676-0115

SHEET TITLE:	CHECKED BY:
SOUND WALL	R.B.
DRAWN BY:	SHEET #
J.A.	F-4.2
DATE:	
3-1-10	

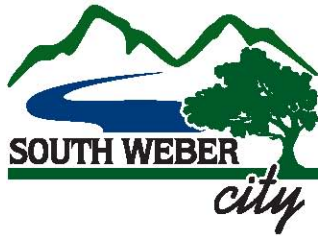

Agenda Item Introduction

Council Meeting Date: April 13, 2021

Name: David Larson

Agenda Item: Davis County Pre-Disaster Mitigation Plan

Background: Davis County is in the process of updating their Pre-Disaster Mitigation Plan having obtained a grant from FEMA. Davis County needs a formal statement of support and agreement to participate from the stakeholder agencies, including South Weber City. Additional information about the planning process can be found at <https://davishazardplan.org/>

Summary: Provide resolution of support for the Davis County Pre-Disaster Mitigation Planning effort

Budget Amendment: n/a

Procurement Officer Review: Budgeted amount \$ Bid amount \$

Committee Recommendation: n/a

Planning Commission Recommendation: n/a

Staff Recommendation: n/a

Attachments: Introduction letter from County Emergency Manager
Plan Overview
Resolution 21-21



Davis County Sheriff's Office

Kelly V. Sparks
Sheriff

Arnold Butcher
Chief Deputy
Corrections

Susan M. Poulsen
Chief Deputy
Administration

Andrew Oblad
Chief Deputy
Law Enforcement

South Weber City Council
c/o Derek Tolman, dtolman@southwebercity.com

February 1, 2021

RE: DAVIS COUNTY PRE-DISASTER MITIGATION PLAN

A Pre-Disaster Mitigation Plan (PDM) is intended to promote sound public policy and protect or reduce the vulnerability of the citizens, critical facilities, infrastructure, private property, and the natural environment within the County. A PDM is required by the Federal Emergency Management Agency (FEMA), and the updated Pre-Disaster Mitigation Plan MUST comply with FEMA rules.

Davis County developed a PDM that FEMA approved in 2016. The County has a strategic imperative to have its existing plan updated and approved before it expires in late 2021. They have received a grant in support of its initiative in part because local staff time that can be dedicated toward this work is limited.

The process to develop a PDM involves a significant amount of data analysis and coordination between numerous state agencies, municipalities in and adjacent to Davis County, many special service districts, and other community organizations. For the plan to gain this support, the project will need to be managed carefully, information will need to be communicated clearly, and time will need to be reserved for revisions and for the various local adoption processes.

In order for this initiative to proceed, Davis County needs a formal statement of support and agreement to participate from the primary stakeholder agencies. We have attached content that we would suggest for your jurisdiction's resolution of support.

Davis County has retained a consultant to help with this initiative (Mike Hansen, Rural Community Consultants). Their team will likely be contacting your office throughout this planning process. Due to the pandemic, they will be focusing most of our interaction through online resources that will be associated with the <https://DavisHazardPlan.Org/> website.

Chad Monroe
Emergency Manager, Davis County
(801) 451-4129 (office)
(714) 655-3620 (cell)

PRE-DISASTER MITIGATION PLAN, 2021 UPDATE

A Pre-Disaster Mitigation Plan is intended to promote sound public policy and protect or reduce the vulnerability of the citizens, critical facilities, infrastructure, private property, and the natural environment within the County. A PDM is required by the Federal Emergency Management Agency, and the updated Pre-Disaster Mitigation Plan MUST comply with FEMA rules.

Davis County developed a PDM that FEMA approved in 2016. The County has a strategic imperative to have its existing plan updated and approved before it expires in late 2021. They have received a grant in support of its initiative in part because local staff time that can be dedicated toward this work is limited.

The process to develop a PDM involves a significant amount of data analysis and coordination between numerous state agencies, every municipality in Davis County, and many special service districts. In order for the plan to gain this support, the project will need to be managed carefully, information will need to be communicated clearly, and time will need to be reserved for revisions and for the various local adoption processes.

DavisHazardPlan.org

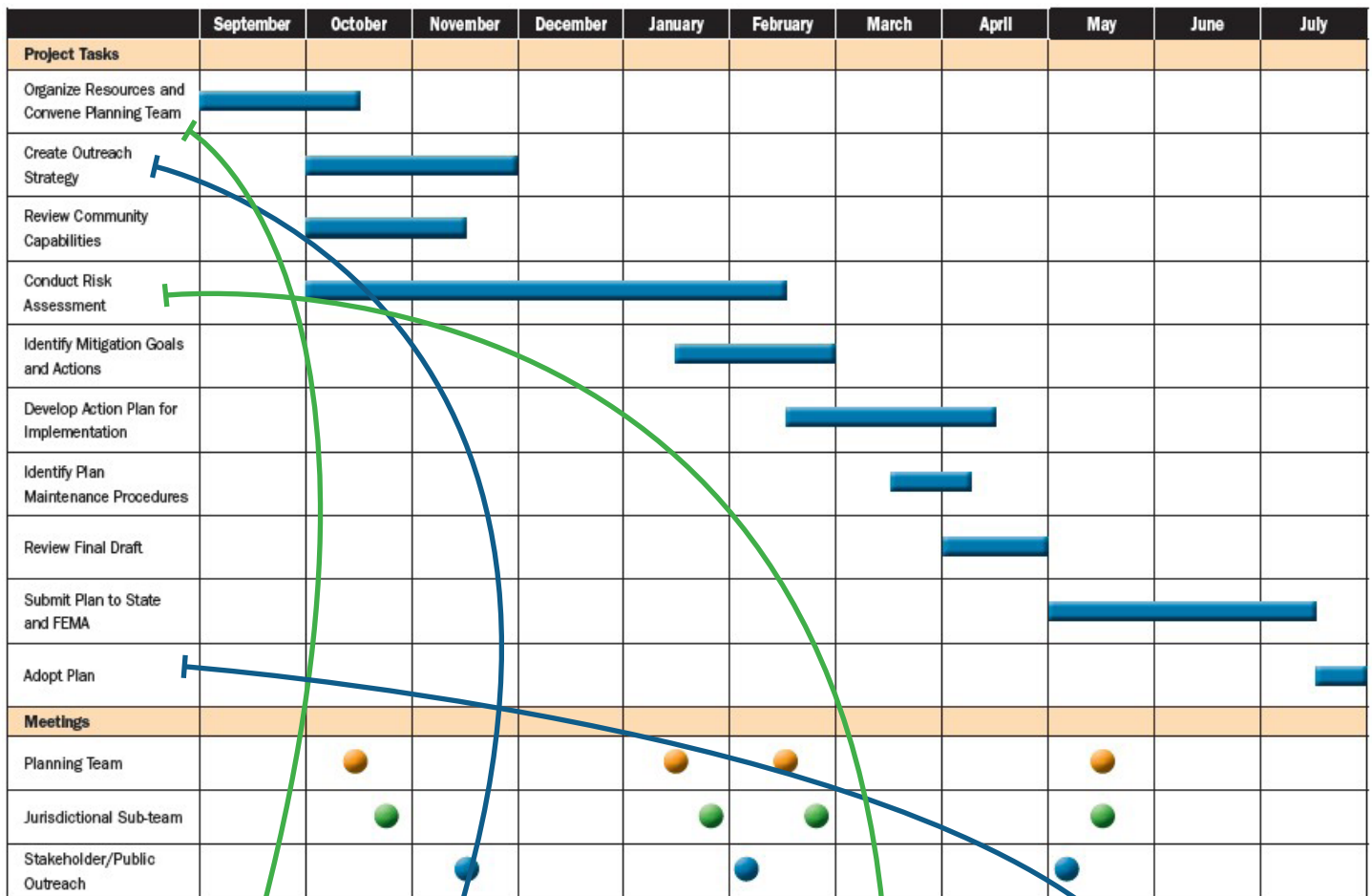

FEMA recommends a MOU at the beginning of the process in order to set expectations for Emergency Managers.

The uncertainty with COVID will drive us to focus the public interaction to be primarily online. (NEED = local social media accounts, newsletters, etc).

We intend to invest in the conversion of the project site into an ongoing resource that will be useful to the public.

Each jurisdiction needs to formally approve/adopt the final plan before FEMA will adopt it.

RESOLUTION 21-24
A RESOLUTION OF THE SOUTH WEBER CITY COUNCIL TO
SUPPORT THE DAVIS COUNTY MULTI-JURISDICTIONAL
PRE-DISASTER MITIGATION PLAN UPDATE

WHEREAS, the health, safety, and welfare of the citizens of South Weber City are matters of paramount importance to the City Council; and

WHEREAS, the City Council recognizes the threat that natural hazards pose to people and property within its jurisdiction; and

WHEREAS, the Federal Emergency Management Agency (“FEMA”) has required that municipalities review and revise their local multi-hazard mitigation plan every five years to reflect changes in development, progress in local hazard mitigation efforts, and changes in mitigation priorities and submit their revised multi-hazard mitigation plan for review and approval by FEMA to remain eligible for pre-disaster mitigation grant funding; and

WHEREAS, the Emergency Services Division of Davis County has received a grant from FEMA to prepare a multi-jurisdictional hazard mitigation plan in accordance with the requirements of 44.C.F.R. 201.6 and the FEMA “Local Mitigation Planning Handbook”; and

WHEREAS, these requirements include obtaining formal resolutions of participation and support from stakeholder jurisdictions;

NOW THEREFORE, BE IT RESOLVED that the City Council of South Weber City hereby intends to support the Plan update initiative by participating with the committee intended to develop revisions and updates to the Davis County Pre-Disaster Mitigation Plan.

This Resolution shall take effect upon passage.

PASSED AND ADOPTED by the City Council of South Weber, Davis County, on the 13th day of April 2021.

Roll call vote is as follows:		
Council Member Winsor	FOR	AGAINST
Council Member Petty	FOR	AGAINST
Council Member Soderquist	FOR	AGAINST
Council Member Alberts	FOR	AGAINST
Council Member Halverson	FOR	AGAINST

Jo Sjoblom, Mayor

Attest: Lisa Smith, Recorder

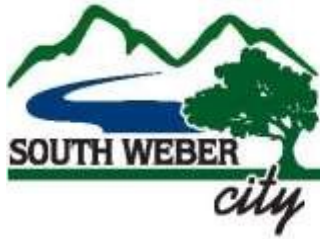

Agenda Item Introduction

Council Meeting Date: April 13, 2021

Name: David Larson

Agenda Item: Development Approach for General Plan Crosshatch

Background: In updating the General Plan recently, the City Council determined to approach the development of certain larger commercial properties with requiring a development plan “master plan” and development agreement rather than letting the property subdivide and develop a piece at a time over an undetermined period.

The General Plan is a guide and aspirational document. Specific zoning decisions will refer to that plan but are made by the City Council in its legislative capacity considering all relevant factors, following the process required by LUDMA and City Code, and at the time a rezone and project application come forward together. Tonight’s conversation is not a zoning decision, but a more general conversation about how to approach zoning and development considerations on the General Plan crosshatch properties.

As development plan concepts for these areas have been presented and discussed, the additional need to discuss the pros & cons, or tradeoffs, of these two approaches has become necessary. Specifically, during the March 23, 2021 City Council meeting during reports, the Council expressed a desire to discuss these approaches in more depth during the April 13 meeting.

Below is a brief comparison of the two approaches. The comparison is a starting point for discussion and not intended to be all inclusive. The Council may choose to pivot from the current master plan approach to the subdivision approach one time if desired.

Master Plan	Subdivision (Administrative)
Single developer/project	Multiple developers/projects
Single point in time	Built out over time
Bound to current economic conditions	Adaptable to economic conditions over time
Planned compatibility of design/uses/traffic flow	Limited compatibility of design/uses/traffic flow
Quicker construction timeline	Unknown construction timeline
Potential for empty buildings (speculation)	Built out as tenants ready (build to suit)
All components viable at the same time	One end user at a time
Additional public spaces/benefits	Allowed uses
Additional legislative input	Simply administer code

Summary: Discuss and direct the development approach on the General Plan crosshatch areas

Budget Amendment: n/a

Procurement Officer Review: n/a

Committee Recommendation: n/a

Planning Commission Recommendation: n/a

Staff Recommendation: n/a

Attachments: n/a

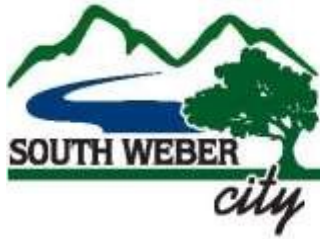

Agenda Item Introduction

Council Meeting Date: April 13, 2021

Name: David Larson

Agenda Item: Poll Gateway Development Agreement Draft

Background: The City Council previously discussed a development concept plan presented by Colliers, International on the Poll property west of the charter school. The General Plan requires a development plan and development agreement as part of a complete project proposal.

The development agreement is one component for a complete project proposal and elements of the agreement must inform the developer how to proceed with the creation of the development plan.

At times in the past, a working committee has drafted agreements before being presented to the full City Council. However, during the City Council meeting on March 9, 2021, staff was tasked with drafting an initial development agreement for full Council discussion prior to negotiating further with the project developer.

The first draft is attached. The Council will not be approving or denying the development agreement tonight, simply giving input on the agreements' creation.

Summary: City Council provide input on the draft development agreement for South Weber Gateway Project on the Poll property.

Budget Amendment: n/a

Procurement Officer Review: n/a

Committee Recommendation: n/a

Planning Commission Recommendation: n/a

Staff Recommendation: n/a

Attachments: Development Agreement Draft
Development Concept Updated April 6, 2021

**DEVELOPMENT AGREEMENT
FOR THE
SOUTH WEBER GATEWAY**

THIS DEVELOPMENT AGREEMENT (the "Agreement") is made and entered into as of the _____ day of _____, 2021, by and between the SOUTH WEBER CITY, a municipal corporation of the State of Utah, hereinafter referred to as the "City," and the JANE M. POLL TRUST, hereinafter referred to as the "Developer." City and Developer are sometimes referred to collectively herein as the "Parties," and individually as a "Party."

RECITALS:

- A. The Developer owns approximately 10.731 acres of land located at 7872 South 2310 East South Weber Drive in South Weber, Utah ("Property").
- B. South Weber City's Zone Map presently identifies Property as being zoned Agricultural (A).
- C. South Weber City's General Plan identifies a future, planned zoning designation for the Property as Commercial-Highway (C-H).
- D. In recognition that other compatible uses may be necessary for the Property to develop as a single project, the General Plan contemplates a "Development Plan and Agreement Required" to establish a zoning designation other than A or C-H on the Property.
- E. Developer has filed two applications with the City—a re-zone application seeking to establish a portion of the Property as C-H and the remaining portion as Residential Multi-Family (R-7), and an application to develop a project on the Property composed of commercial and residential components (the "Project").
- F. Consistent with the General Plan, Developer's applications are conditioned on entering into this Agreement to re-zone the Property and to set out Developer's rights and obligations with respect to the development of the Property.
- G. Developer's applications have been or are being reviewed by the City's Planning Commission and approved by the City Council along with this Agreement and pursuant to the City's ordinances, guidelines, and policies.
- H. All approvals or issuance of permits for the Project are subject to specific conditions of approval. This Agreement includes various conditions consistent therewith which must be satisfied by Developer in development of the Project. Unless otherwise specifically excepted herein, the portion of the Property containing the Project and development of the Project is subject to all of the City's ordinances and regulations including, but not limited to, the provisions of the City's General Plan, the City's Zoning Regulations, the

City's Subdivision Regulations, and any permits issued by the City pursuant to the foregoing ordinances and regulations, collectively referred to as the "City's Laws."

- I. Developer acknowledges that the City is relying on the faithful performance by Developer of the terms and conditions of this Agreement in consideration of the separate land use approvals and development rights for the Property approved by the City concurrent with this Agreement.
- J. The City acknowledges that Developer is relying on the continuing validity of this Agreement in exchange for Developer's commitment to the expenditure of substantial funds for the improvements and facilities that Developer is obligated to provide pursuant to this Agreement.

AGREEMENT

NOW, THEREFORE, in consideration of the mutual covenants contained herein, and other good and valuable consideration, the receipt and sufficiency of which is hereby acknowledged, the City and Developer hereby agree as follows:

1. Incorporation of Recitals. The Recitals are hereby incorporated into this Agreement.
2. Description of Developer's Land. The legal description of the Property that is covered by this Agreement is attached as Exhibit "A" to this Agreement and is incorporated into this Agreement by reference. No additional property may be added to this Agreement except by written amendment of this Agreement upon recommendation by the Planning Commission and approval by the City Council in accordance with the City's ordinances, policies, and guidelines in effect at the time of such amendment.
3. Property Development. Concurrent with or prior to execution of this Agreement, the City has re-zoned the Property as Commercial-Highway (C-H), in part, and Residential Multi-Family (R-7), in part, as designated in the applicable re-zoning ordinance and depicted in the Project Master Plan. Such zoning designations are site-specific and conditioned on Developer's compliance with the terms and conditions of this Agreement, and applicable state and municipal law, to develop the Property as a single, master-planned project consisting of commercial, townhome, and apartment units on the relevant portions of the Property.
4. Project Master Plan. The Project Master Plan is attached hereto as Exhibit "B" and incorporated herein by this reference. The Property shall be developed by the Developer and/or any successor developers in accordance with the Project Master Plan. All submittals should comply with the Project Master Plan. The approved Project Master Plan may only be amended with the approval of the City Council and Developer in accordance with all applicable state and municipal law. Approval of this Agreement constitutes the City's approval and acceptance of the Project Master Plan.

Developer shall be entitled to minor variations from literal depictions contained in the

Project Master Plan without amendment, if such variations do not constitute a material change in the Project Master Plan. For purposes of this Agreement a "material change" is defined as a change that:

- a. will have a measurable and significant negative impact on those properties which are adjacent to the Property;
- b. create a significant and measurable public safety hazard to the Property or its current or future residents;
- c. increases the overall density of the Project; or
- d. adds significant operation and/or maintenance costs to the County.

5. Development of the Project. The Project shall be developed by the Developer and/or Developer's successors and assigns in accordance with the Master Development Plan, all of the conditions of approval granted by the City for the Project, and all of the terms and requirements contained herein. Developer shall be required to apply for and obtain approval for each concept plan and each subdivision and/or site plan, and to otherwise comply with all provisions of the City's ordinances. Except as otherwise expressly provided herein, the requirements of this Agreement shall be in addition to and not in lieu of the requirements of the City's ordinances, regulations and guidelines. Developer's vested right of development of Developer's Land pursuant to this Agreement is expressly subject to and based upon strict compliance and performance by Developer of all of the terms, conditions and obligations of Developer under this Agreement and the other Exhibits attached to this Agreement.

- a. Architectural Site Plan Review. The Project must comply with the City's building design, setback, and landscaping requirements. Developer shall follow the Architectural Site Plan Review process contained in Title 10, Chapter 12, of City Code.
- b. Geotechnical and Geologic Study. Developer must identify any and all potential hazards that would be detrimental to the Project, mitigating recommendations, and otherwise comply with the Sensitive Lands Development Regulations contained at Title 10, Chapter 14 of City Code.
- c. Traffic Impact Study. Developer must complete a traffic impact study. The study must include the following:

6. Subdivisions and Site Plans. Neither the Project Master Plan nor the approval of the re-zone application constitutes a subdivision of the Property, nor site plan approval of the Property or any portion thereof. All future subdivisions of the Project shall comply with the provisions of this Agreement and applicable law.

7. Commercial Square Footage and Phasing. The total commercial square footage of the Project shall be no less than _____ square feet. At least _____ square feet of commercial property shall be developed before any

residential units may be built.

8. Residential Maximums. The total number of residential units shall not exceed seventy-five (75) units. This total includes townhome and apartment units.

9. Community Gathering Places. The Project shall provide multiple community gathering places and amenities in the locations and according to the specifications identified on the Master Development Plan. Community gathering places and amenities shall be considered public improvements as that term is used in this Agreement.

10. Height Restrictions. No structure in the Project may exceed the “eyeline view” of residents on View Lane. “Eyeline view” means approximately six (6) feet above the ground level of the homes on View Lane.

11. Pedestrian Trail. At its sole expense, Developer agrees to design and construct a trail along the hillside that will connect pedestrian traffic from View Lane to South Weber Drive. The trail system shall be constructed according to the specifications and standards outlined in the Site Plan. The trail must be paved at a minimum width of eight-feet (8'). The Pedestrian Trail shall be considered public improvements as that term is used in this Agreement.

Commented [JB1]: Who will maintain this trail? Will the City require dedication?

12. Parking. Parking standards from Section 10-8-5(c) of South Weber City Code shall be used to determine the number of parking spaces required for the project. A minimum of two (2) parking spaces per dwelling unit, plus an additional space per every three (3) units shall be required for all residential units. Parking spaces in privately owned garages and driveways longer than twenty-feet (20') may be counted for purposes of this analysis. Three and one-half (3.5) spaces shall be required for every one-thousand (1,000) square feet of commercial floor space. By applying these standards to the Site Plan, the minimum number of parking spaces required for the Project is _____. By terms satisfactory to the City, Developer, its successors, and assigns shall prohibit patrons and residents of the Project from parking outside of the provided parking spaces.

13. On-Site Road and Public Improvements. Developer shall construct or cause to be constructed, all on-site roads and public improvements for the roads dedicated in the Street Dedication Plat, including, but not limited to, the 70 East Street extension pursuant to applicable City Laws. As a condition of approval for the Project, Developer will design, install and construct the 70 East Street extension as shown on the site plan and the Street Dedication Plat pursuant to the terms and conditions of the Public Improvements Extension and Reimbursement Agreement dated as of _____ between the City and Developer (the “Extension Agreement”), attached hereto as Exhibit “A”, and incorporated herein by reference.

14. UDOT Approvals. Prior to any portion of the Project being developed, Developer must receive approval from the Utah Department of Transportation (“UDOT”) for its proposed access points onto South Weber Drive (SR-60) and for proposed storm drain connection into UDOT’s system in South Weber Drive (SR-60) along with storm water detention as required by UDOT.

15. Stormwater. The Project must comply with State requirements for Stormwater Low Impact Development (“LID”).

Commented [JB2]: Does this require approval from the State?

16. Culinary Water. Culinary water service for the Project must be privately owned and maintained, separate from the fire protection system, and fully metered.

17. Fire Protection. The fire protection system (including but not limited to waterlines, fire hydrants, and fire lines to buildings) for the Project must have two looping connections to the waterline in South Weber Drive. The fire protection system shall be privately owned and maintained. It is not required to be metered.

18. Sewer. [This is a placeholder.]

Commented [JB3]: City Engineer notes that ERUs for sewer may need to be limited. This is an item for discussion.

19. Maintenance Entities. [This is a placeholder.]

Commented [JB4]: I assume this means an HOA, but wanted to discuss first.

20. Lighting. All lighting in the Project shall be dark-sky compliant.

21. Public Use of Detention Basin. The City agrees to allow public use of the detention basin located immediately east of the Project. Developer shall install a gate providing access between the Project and the detention basin.

Commented [JB5]: City needs to verify whether it can grant this right pursuant to agreement with charter school.

22. Utility Dedication and Donation. Prior to the granting of any Building Permits for the Project, Developer agrees to dedicate, transfer and voluntarily donate to the City all required rights-of-way and easements for the purpose of constructing, installing, operating, maintaining, repairing and replacing public utilities and improvements required for the Project as shown on the Site Plan, and Street Dedication Plat or as otherwise mutually agreed to by the parties.

23. Construction Standards and Requirements. All construction shall be conducted and completed in accordance with the City Laws and development standards of the City. All required improvements for the Project shall be constructed in accordance with the City's construction standards and/or plans specifically approved for the Project, and all required public improvements and easements shall be dedicated to the City. The Developer shall construct, or cause to be constructed, all improvements for the Project in conformity with all applicable federal, state and/or local laws, rules and regulations. Security in the form of an escrow deposit account or letter of credit shall be provided by Developer related to the public improvements to ensure construction of all off-site and on-site public improvements in a form acceptable to the City, which security must be provided prior to the grant of any building permits. All public improvements required for the Project shall be completed prior to the issuance of a building permit for construction of a structure within the Project. Access, parking areas and lighting shall be constructed to serve each building prior to occupancy of that building.

24. Ownership of Public Improvements. Unless otherwise provided herein, ownership of all public improvements installed by Developer in conjunction with the Project in accordance with the terms of this Agreement shall be transferred to the City upon acceptance of the same by the City. The City shall not be responsible for maintenance of such improvements until acceptance of the same.

25. Engineering Standards. Developer shall comply with all engineering requirements for the Project. All road dedication and design plats, site plans, landscaping plans, and other engineering drawings for the Project shall be reconciled for all elements of the proposed development prior to recording of the Off-Site Street Dedication Plat.

26. Public Works Requirements. Except as otherwise provided herein, all South Weber City requirements for drainage, detention, utility alignments, street improvements, dedication of roads, bonding for improvements, and other requirements shall be met. All final plans containing required corrections shall be prepared and submitted in conjunction with this Agreement.

27. Required Permits. Before commencement of construction or development of any building, structures, grading or other work or improvements upon any portion of the Project for which a permit is required, Developer shall, at its expense, secure any and all such permits which are required by the City or any other governmental agency having jurisdiction over the work or affected by its construction or development. Failure by the Developer to obtain all required permits when due shall constitute a default on the part of the Developer under this Agreement.

28. Payment of Fees. The Developer shall pay all required fees to the City in a timely manner which are due or which may become due pursuant to the City's Laws in connection with the Project or any phase thereof. Developer and its successor(s) shall pay all required fees to the City in those amounts which are in effect at the time the fees are actually paid to the City.

29. City Obligations. Subject to the Developer complying with all of the City's Laws, rules and regulations and the provisions of this Agreement, the City agrees to provide, or cause to be provided, standard municipal services to the Project including police and fire protection, subject to payment of all fees and charges charged or levied therefor by the City.

30. Indemnification. Developer hereby agrees to indemnify and hold the City and its officers, employees, representatives, agents and assigns, harmless from all liability, loss, damage, costs or expenses, including attorney's fees and court costs, arising from or as a result of the death of any person or any accident, injury, loss, or damage whatsoever caused to any person or to property of any person which shall occur within the Project or occur in connection with any off-site work done for or in connection with the Project during the construction of the Project caused by the negligent act or omission of the Developer or of its agents, contractors, servants, or employees. Developer shall furnish or cause its contractor to furnish to the City a certificate of insurance evidencing general public liability coverage maintained by the Developer during the period of the construction of the Project.

31. Compliance with Law. Developer shall comply with all applicable federal, state and City Laws, ordinances, rules and regulations pertaining to Developer's activities in connection with the Project or any phase thereof. The City agrees that the City Laws applicable to Developer and the Project shall be the City Laws that are in effect as of the date of this Agreement, with the following exceptions:

(ii) Compliance with State and Federal Laws. City's Future Laws which are generally applicable to all properties in the City and which are required to comply with State and Federal laws and regulations affecting the Project;

(iii) Safety Code Updates. City's Future Laws that are updates or amendments to existing building, plumbing, mechanical, electrical, dangerous buildings, drainage, or similar construction or safety related codes, such as the International Building Code, the APWA Specifications, AAHSTO Standards, the Manual of Uniform Traffic Control Devices or similar standards that are generated by a nationally or statewide recognized construction/safety organization, or by the State or Federal governments and are required to meet legitimate concerns related to public health, safety or welfare; or,

(iv) Taxes. Taxes, or modifications thereto, so long as such taxes are lawfully imposed and charged uniformly by the City to all properties, applications, persons and entities similarly situated.

(v) Fees. Changes to the amounts of fees (but not changes to the times provided in the City's Vested Laws for the imposition or collection of such fees) for the processing of Development Applications that are generally applicable to all development within the City (or a portion of the City as specified in the lawfully adopted fee schedule) and which are adopted pursuant to State law.

(vi) Countervailing, Compelling Public Interest. Laws, rules or regulations that the City's land use authority finds, on the record, are necessary to avoid jeopardizing a compelling, countervailing public interest pursuant to Utah Code Ann., §10-9a-509(1)(a)(i) (2009), or its successor section(s), or decisions of Courts of record interpreting such section(s)

(vii) Impact Fees. Impact Fees or modifications thereto which are lawfully adopted, imposed and collected.

32. Default. In the event any party fails to perform its obligations hereunder or to comply with the terms hereof within thirty (30) days after written notice of default, the non-defaulting party may, at its election, have the following remedies:

- a. All rights and remedies available at law and in equity, including injunctive relief, specific performance and/or damages.
- b. The right to withhold all further approvals, licenses, permits or other rights associated with the Project until such default has been cured.
- c. The right to draw on any security posted or provided in connection with the Project.

In the event any default under this Agreement is caused by acts of God or circumstances

beyond the control of the Developer, the City, after consulting with Developer, shall grant a reasonable time for such default to be cured. The rights and remedies set forth herein shall be cumulative.

33. Notices. Any notices, requests and demands required or desired to be given hereunder shall be in writing and shall be served personally upon the party for whom intended, or if mailed, by certified mail, return receipt requested, postage prepaid, to such party at its address shown below:

To the Developer:

To City:

South Weber City
Attn: David Larson, City Manager
1600 South Weber Drive
South Weber, Utah 84405

Any party may change its address for notice by giving written notice to the other party in accordance with the provisions of this Section.

34. Attorneys' Fees. In the event of any lawsuit between the parties hereto arising out of or relating to this Agreement, or any of the documents provided for herein, the prevailing party or parties shall be entitled, in addition to the remedies and damages, if any, awarded in such proceeding, to recover reasonable attorneys' fees and costs.

35. Entire Agreement. This Agreement, together with the Exhibits hereto, integrates all of the terms and conditions pertaining to the subject matter hereof and supersedes all prior negotiations, representations, promises, inducements or previous agreements between the parties hereto with respect to the subject matter hereof. Any amendments hereto must be in writing and signed by the respective parties hereto.

36. Headings. The headings contained in this Agreement are intended for convenience only and are in no way to be used to construe or limit the text herein.

37. Non-Liability of City Officials and Employees. No officer, representative, agent or employee of the City shall be personally liable to the Developer, or any successor in interest or assignee of the Developer, in the event of any default or breach by the City, or for any amount which may become due Developer, or its successors or assignees, for any obligation arising under the terms of this Agreement.

38. No Third-Party Rights. The obligations of the parties set forth in this Agreement shall not create any rights in or obligations to any persons or parties other than to the City and the Developer. The City and Developer alone shall be entitled to enforce or waive any provisions of this Agreement to the extent that such provisions are for their benefit.

39. Assignability. Developer shall not assign Developer's obligations under this Agreement or any rights or interests herein without giving prior written notice to the City. Any future assignee shall consent in writing to be bound by the terms of this Agreement as a condition precedent to the assignment and shall enter into an Assignment and Assumption Agreement with Developer. In addition to prior written notice to the City of the proposed assignment as required herein, a copy of the Assignment and Assumption Agreement shall be provided to the City within thirty (30) days from the date of execution of such Agreement. No party shall transfer, assign, sell, lease, encumber, or otherwise convey its rights and obligations under this Agreement separate from that party's interest in the Property except for the lease of apartment units within the Project.

In the event of a sale or transfer of the Property, or any portion thereof, the buyer or transferee shall be liable for the performance of each of the obligations contained in this Agreement as it relates to that portion of the Property it is buying, and acceptance of a deed to any portion of the Property shall constitute an agreement to assume and to be bound by the provisions of this Agreement as it relates to the Property covered by the deed.

In the event of any assignment by the Developer, the assignee, for itself and its successors and assigns, and for the benefit of the City, shall expressly assume all of the obligations of the Developer under this Agreement with respect to the Project, or any portion thereof, which is assigned by Developer to the assignee and the assignee shall agree to be subject to all of the conditions and restrictions to which the Developer is subject with respect to the Project or any portion thereof. Upon proper assignment, Developer shall be released from any future obligations as to any portions of the Property conveyed to assignee(s).

40. Approval of this Agreement. Based upon the recommendation of the Planning Commission and after public hearing and notice as required by the City's Code, the City Council approves this Agreement and authorizes and directs the City Manager to execute this Agreement for and on behalf of the City.

41. Binding Effect. This Agreement shall inure to the benefit of, and be binding upon the parties hereto and their respective heirs, representatives, officers, agents, employees, successors and assigns (if any assignments are allowed as provided hereinabove). This Agreement is a development agreement and is entered through the City's land use authority pursuant to Utah Code Ann. §10-9a-102, and is a binding contract on the City to the full extent of the laws of the State of Utah. The signature of the City Manager is affixed to this Agreement lawfully binding the City. This Agreement is approved as to form and is further certified as having been lawfully adopted by the City by the signature of the City Attorney.

42. No Waiver. Any party's failure to enforce any provision of this Agreement shall not constitute a waiver of the right to enforce such provision. The provisions may be waived only

in writing by the party intended to be benefitted by the provisions, and a waiver by a party of a breach hereunder by the other party shall not be construed as a waiver of any succeeding breach of the same or other provisions.

43. Force Majeure. Any prevention, delay or stoppage of the performance of any obligation under this Agreement which is due to strikes, labor disputes, inability to obtain labor, materials, equipment or reasonable substitutes therefor; acts of nature, governmental restrictions, regulations or controls, judicial orders, enemy or hostile government actions, wars, civil commotions, fires or other casualties or other causes beyond the reasonable control of the party obligated to perform hereunder shall excuse performance of the obligation by that party for a period equal to the duration of that prevention, delay or stoppage.

44. Recordation. This Agreement shall be recorded against the Property senior to any covenants, easements, or debt security instruments encumbering the Property or any portion thereof except for those obligations previously recorded. This Agreement may be recorded by either party hereto in the offices of the Davis County Recorder.

45. Relationship. Nothing in this Agreement shall be construed to create any partnership, joint venture or fiduciary relationship between the parties.

46. Termination. The term of this Agreement shall commence as of the date hereof and shall continue in full force and effect until all conditions and requirements of approval and development are completed, as evidenced by the completion of the Project and issuance of certificates of occupancy for all of the planned apartment units, unless sooner terminated as provided herein

47. Amendment. This Agreement may be amended only in writing signed by the parties hereto.

48. Effectiveness. This Agreement shall be considered effective only when and if the property underlying the Project is transferred to Developer.

IN WITNESS WHEREOF, the parties hereto have executed this Agreement by and through their respective, duly authorized representatives as of the day and year first hereinabove written.

“CITY”
SOUTH WEBER CITY

By: _____
City Manager

ATTEST:

City Recorder

“DEVELOPER”

By: _____
Title: _____

DRAFT

CITY ACKNOWLEDGMENT

STATE OF UTAH)
 :ss.
COUNTY OF UTAH)

On the _____ day of _____, 2021, personally appeared before me David Larson, who being duly sworn, did say that he is the City Manager of SOUTH WEBER CITY, a municipal corporation of the State of Utah, and that the foregoing instrument was signed in behalf of the City by authority of its governing body and said David Larson acknowledged to me that the City executed the same.

My Commission Expires: _____ Residing at: _____

DEVELOPER ACKNOWLEDGMENT

STATE OF _____)
 :ss.
COUNTY OF _____)

On the _____ day of _____, 2021, personally appeared before me _____ who being by me duly sworn did say that (s)he is the _____ of _____, a _____, and that the foregoing instrument was signed in behalf of said corporation by authority of a resolution of its Board of Directors; and they acknowledged to me that said corporation executed the same.

My Commission Expires: _____ Residing at: _____

LIST OF EXHIBITS

DRAFT

**EXHIBIT A
DESCRIPTION OF DEVELOPER'S LAND**

BEGINNING AT A POINT 577.5 FEET SOUTH FROM THE NORTHWEST CORNER OF THE SOUTHWEST QUARTER OF THE NORTHEAST QUARTER OF SECTION 35, TOWNSHIP 5 NORTH, RANGE 1 WEST; SALT LAKE BASE AND MERIDIAN; THENCE NORTH $74^{\circ}45'27''$ EAST 1374.84 FEET TO A POINT 214.5 FEET SOUTH OF THE NORTHEAST CORNER OF THE SOUTHWEST QUARTER OF THE NORTHEAST QUARTER; THENCE SOUTH 67 RODS; THENCE WEST 1290.0 FEET; THENCE NORTH 742.5 FEET; THENCE WEST 30.0 FEET TO POINT OF BEGINNING CONTAINING 27.49 ACRES (13-034-0015).

DRAFT

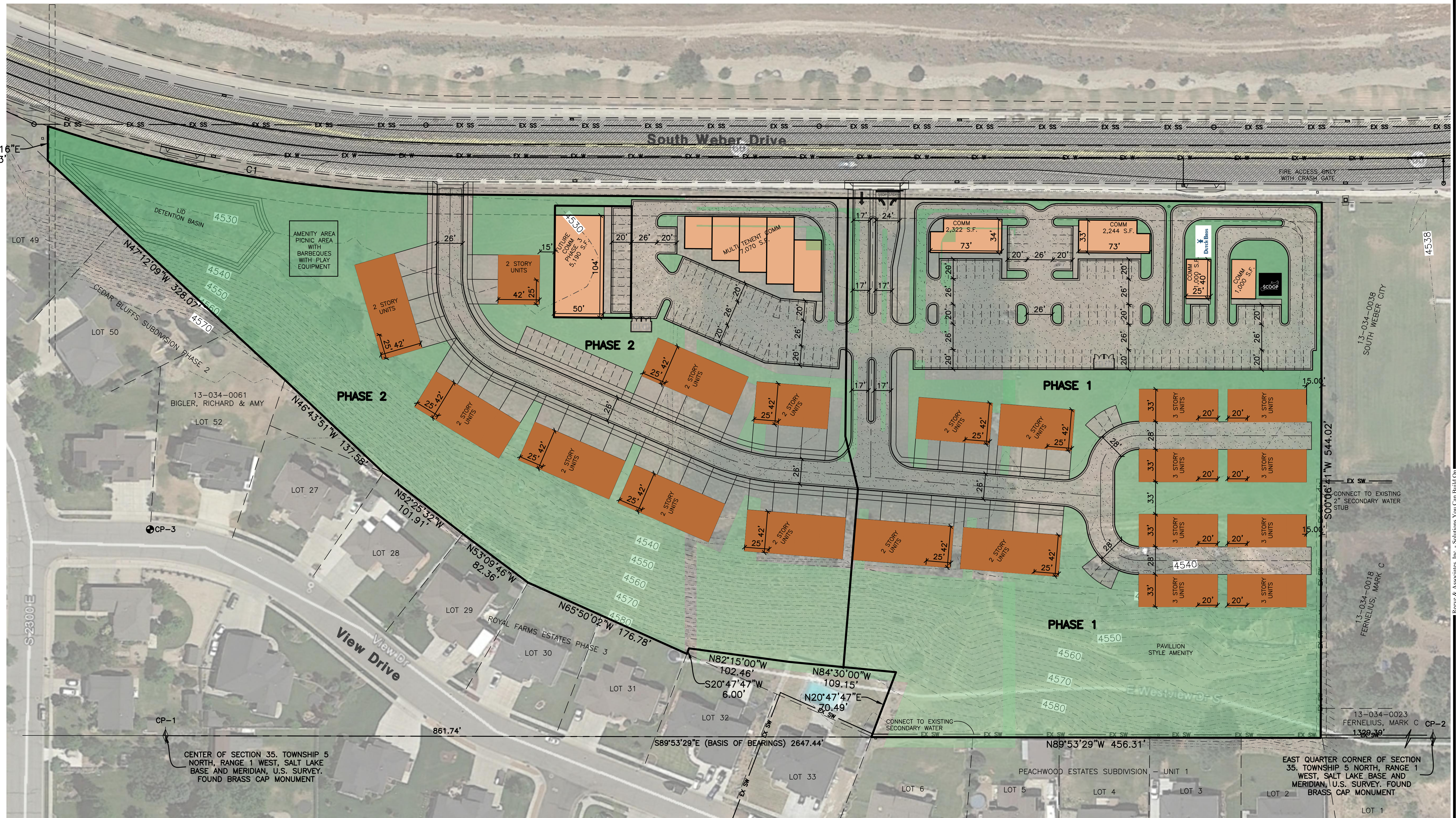

REVISIONS

DATE	DESCRIPTION

South Weber Gateway
SOUTH WEBER CITY, DAVIS COUNTY, UTAH
Sketch Plan

Reeve & Associates, Inc. - Solutions You Can Build On

Reeve & Associates, Inc. - Solutions You Can Build On



- Current Zone: Agricultural
- General Plan Designation: Highway Commercial With Development Plan/Agreement Required
- Proposed Zone: Highway Commercial & R7

Site Information

APN# 13-034-0068
APPOX. 2350 EAST SOUTH WEBER DRIVE
(ADDRESS NOT ASSIGNED)
SOUTH WEBER, DAVIS COUNTY, UTAH

TOTAL PARCEL AREA.....507,182 s.f./11.6 acres
COMMERCIAL ZONE.....HIGHWAY COMMERCIAL
COMMERCIAL BUILDINGS.....2.94 ACRES
COMMERCIAL BUILDING AREA.....18,824 S.F.
COMMERCIAL PARKING STALLS.....142 PROVIDED
3.5 PER 1,000 S.F. = 66 REQ.

TOWNHOME ZONE.....R7
TOWNHOME UNITS.....43 (2 STORY UNITS)
32 (3 STORY UNITS)
TOWNHOME UNIT AREA.....26,583 S.F.
TOWNHOME PARKING236 PROVIDED
2.3 PER UNIT = 175 REQ.

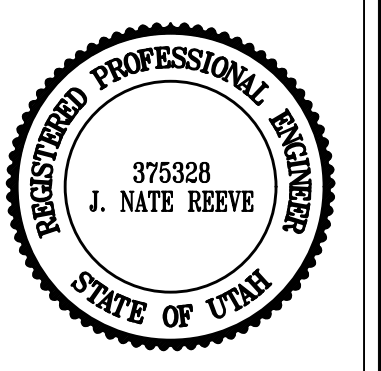
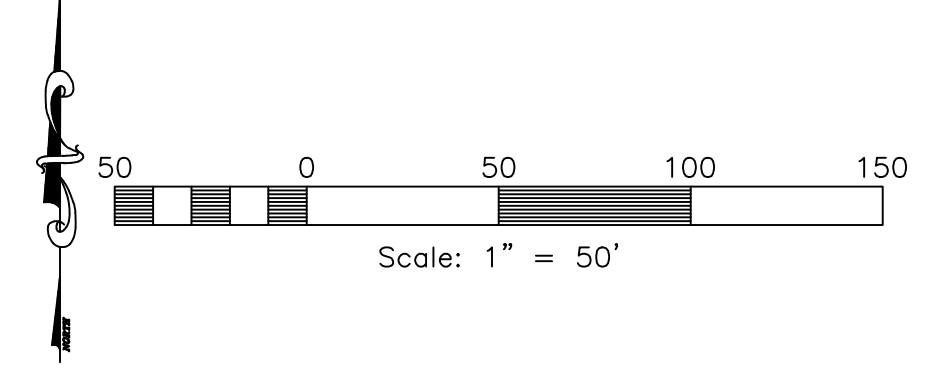

Project Info.
Engineer: J. NATE REEVE, P.E.
 Drafter: R. HANSEN
Begin Date: FEBRUARY 19, 2019
Name: SOUTH WEBER GATEWAY SKETCH PLAN
Number: 7152-05

Developer Contact:
Sky Hazlehurst
CBC Advisors
6550 S Millrock Dr. Suite 200,
Salt Lake City, UT 84121
PH: (801) 844-1420

Project Contact:
Project Manager: Nate Reeve, P.E.
Project Engineer: Nate Reeve, P.E.
Reeve & Associates, Inc.
801-621-3100